

October

25 Cents



# Radio-Craft

for the  
Professional-Serviceman-Radiotrician

HUGO GERNSBACK Editor

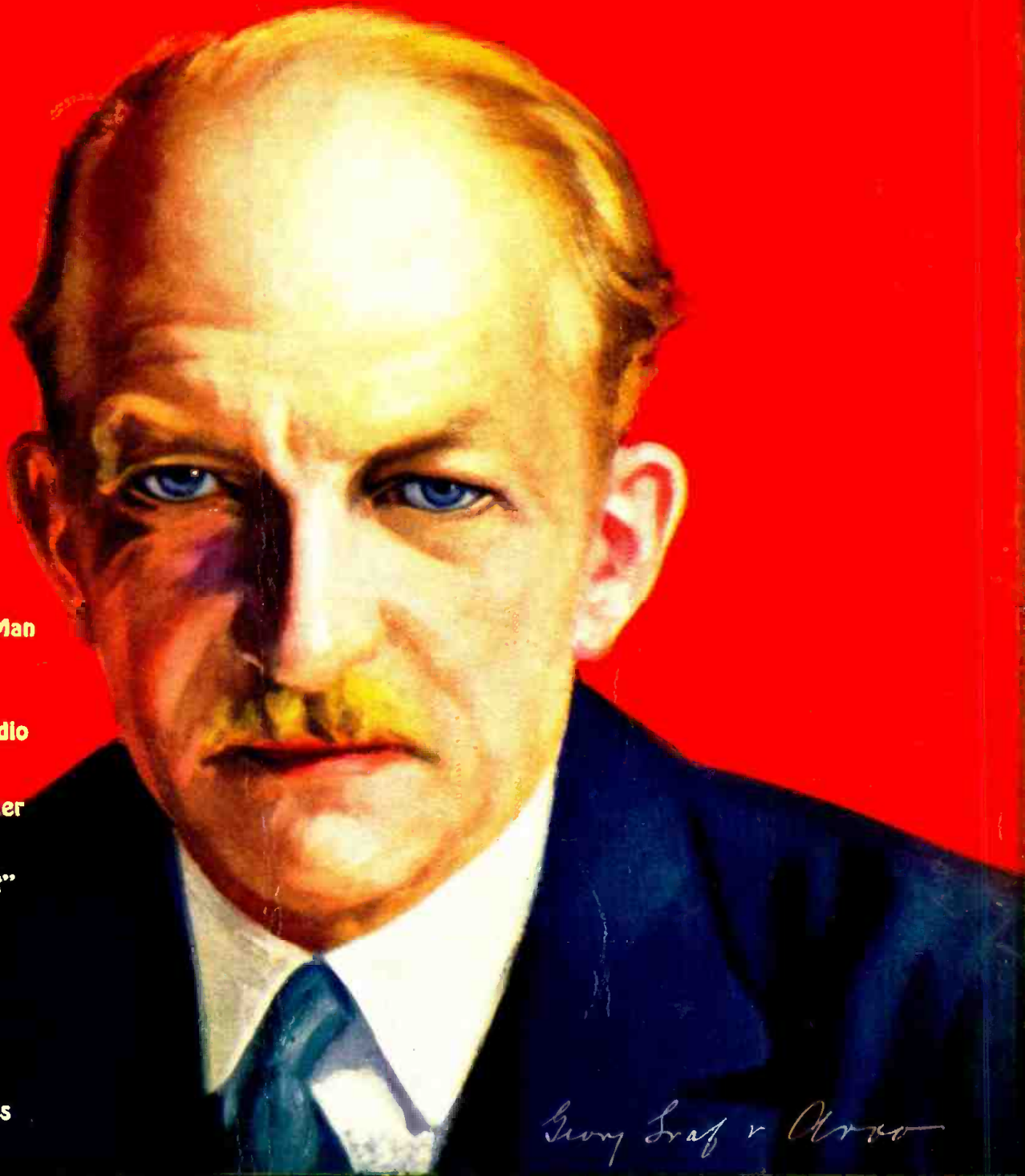

What Should the Service Man Know?

By JOHN F. RIDER

Servicing Automotive Radio

By J. KENNETH WINDLEY

A Public-Address Amplifier

By HOWARD SMITH

The "Stenode Radiostar"

By CLYDE J. FITCH

Service Men's Notes

Television Progress

Radio-Craft Kinks

And Many Other Articles

*Georg Graf v Arco*

**Men who have made Radio:** Count Georg von Arco



# RADIO WANTS MEN TRAINED AS R. T. I. TRAINS THEM AT HOME FOR PRACTICAL WORK

Radio wants trained men and pays them well. This great industry would rather pay Big Money to men trained as R. T. I. Trains them, than low wages to untrained "tinkers" and "guessers." Trained radio men can easily make \$40 to \$100 per week and upwards. With training and experience many make \$75 to \$100 per week and are always in demand. Get the inside facts from leading radio men in the free "R. T. I. Radio Opportunity Book."

**BETTER JOBS - BIGGER PAY**  
R. T. I. offers you the way to get into Radio right, and the definite path to the Better Jobs and Bigger Pay. You need no experience to start. You can quickly make \$10 to \$20 per week Extra Money in spare time while learning.

**APPROVED TRAINING**  
R. T. I. training is endorsed by leading Radio Concerns and Radio Trade Associations. It is prepared and supervised by well known men in different branches of radio. You will find it interesting, practical, thorough and easy to understand.

**LEARN AT HOME**  
Why? Because the fellow who trains at home the R. T. I. way learns rapidly and makes a most valuable man. R. T. I. Gives you the training the radio industry wants you to have for important, well-paid work.

Make your success certain. Start R. T. I. training in radio now. Go on up in this great money-making industry that is becoming part of all our daily life. Entertainment, Education, Business, Transportation, News—all depend more and more upon radio.

**GET PAID FOR WHAT YOU KNOW**  
Be a trained man. R. T. I. gives you money-making radio training and keeps you up-to-the-minute with its service. No more worry about jobs when you complete R. T. I. training.

**TELEVISION**  
This amazing new branch of radio is part of the R. T. I. training. (No extra charge.) Be prepared for this new work—Television Service-men will soon be in demand.

**TALKING PICTURES**  
Require trained men—in the studios—the theatres—for servicing and installing the apparatus, and R. T. I. training covers this, too. Broadcasting Stations; Airplane Radio Apparatus; Sea-going Ship Radio Operating; Radio factories; Short Wave Work; Receiving Set Servicing; Selling, Repairing, etc. All these opportunities are included in R. T. I. training.

**Free Opportunity Book**  
Get the facts about the opportunities in Radio, Television and Talking Pictures in this wonderful book—it is free.



**Let F. H. Schnell**  
and the R. T. I. Advisory Board Help You  
20 years' Radio Experience. First to establish 2-way amateur communication with Europe. Former Traffic Mgr. of Am. Radio Relay League, Lieut. Com. U. S. N. R. Inventor and Designer. Cons. Radio engineer.

Assisting him is the R. T. I. Advisory Board, composed of men prominent in the Radio Industry—manufacturing, broadcasting, engineering and servicing. All these men know Radio and will help you succeed in their field.

**RADIO & TELEVISION INSTITUTE**  
4806 St. Anthony Ct., Chicago, Dept. 767

**Mail Coupon for Big FREE BOOK**

**RADIO & TELEVISION INSTITUTE**  
4806 St. Anthony Court, Chicago, Dept. 767

Send me Free and prepaid your BIG RADIO OPPORTUNITY BOOK, "Tune In On Big Pay," and full details of your three-in-one Home Training (without obligating me in any way).

Name

Address

City  State

**THE R. T. I. ADVISORY BOARD.** These men are executives with important concerns in the radio industry—manufacturing, sales service, broadcasting, engineering, etc., etc. They supervise R. T. I. Work Sheets, Job Tickets, and other training methods.

**R. T. I.** R. T. I. TRAINS YOU AT HOME FOR A GOOD JOB OR A PROFITABLE PART TIME OR FULL TIME BUSINESS OF YOUR OWN

# Let these Radio Leaders . . . . . . Help Train You for RADIO

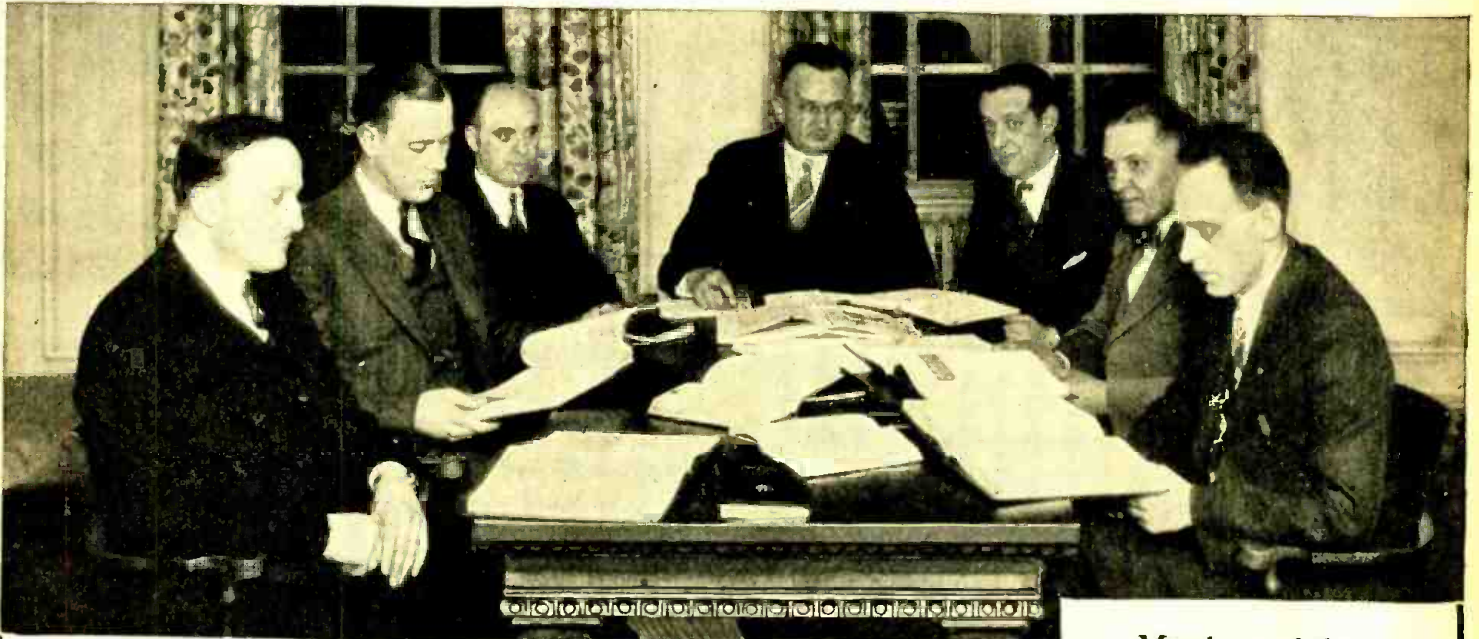

### Members of the R.T.A. Advisory Board

— o —  
**ARTHUR G. MOHAUPT, B.A., M.S.**  
President R.T.A.

Graduate of the University of Wisconsin, and his many years experience with prominent engineering companies and technical schools specially qualifying him for the great work he is doing for R.T.A.

#### **KENNETH HATHAWAY**

Associate Editor Radio Industries Magazine; Associate Radio Editor Chicago Daily News; Authority on Television, and Air-Craft Radio.

#### **E. H. SCOTT**

President of Scott Transformer Co.; Designer of World Record Superheterodyne receivers; manufacturer of high-grade custom-built radio receivers.

#### **LIEUT. K. R. COX**

Supt. of Police Radio, Chicago; Pioneer in automobile radio; authority on short-wave transmission; licensed aviator.

#### **CHARLES S. HIMMEL**

V.-P. and Gen. Mgr. Hudson-Ross, Inc., Crosley distributors; chairman Mayor's Radio Commission, Chicago; Secretary Midwest Radio Trades Ass'n; Chairman Radio Dealers Audit Bureau; member executive board R.M.A.

Each member of the R.T.A. Advisory Board is a leader in a special line. Each brings to the course offered by the Radio Training Association an expert knowledge based on experience, and is in a position to keep the course abreast with Radio's latest developments. These men *know* what you should *know* to make good in Radio in the very shortest possible time.

Graduates of the R.T.A. course are in demand. You will find them everywhere: in radio laboratories and factories, broadcasting stations, on ocean liners, and heading big radio departments or radio businesses of their own. They are in demand because they have their feet on the ground. Unencumbered by useless theory or out-of-date knowledge, they earn their salary from the start and merit rapid promotion and advancement.

The training you will secure from the R.T.A. will enable you to earn \$3.00 an hour spare time thirty days after you start. Our members earn thousands of dollars monthly while fitting themselves for Radio. Theory and practice are combined so as to make money for our members. R.T.A. training has the endorsement of the Radio industry and the thousands of men who go through it have attained more pay, greater opportunities, more happiness out of life.

Investigate what Radio has to offer you! Learn how the Radio Training Association of America can help you cash in on radio quick, start you in business, get you more pay, enable you to earn \$15.00 to \$50.00 a week spare time, \$50.00 to \$100.00 a week full time.

### **WRITE FOR NO-COST TRAINING OFFER**

If you are ready to start now, we will make it possible for you to secure your training by a No-Cost Membership that need not—should not—cost you a cent. To get one, fill out coupon today. Get started in Radio without delay by mailing us the coupon right away.

### **RADIO TRAINING ASSOCIATION OF AMERICA**

4513 Ravenswood Avenue . . . Chicago, Ill.

**RADIO TRAINING ASSOCIATION OF AMERICA,**  
Dept. RCA-10, 4513 Ravenswood Ave., Chicago.

Without cost or obligation to me, send me your book, "Your Opportunity in the Radio Industry."

Name .....

Address .....

City..... State.....

H. GERNSBACK, President  
 S. GERNSBACK, Treasurer  
 J. M. HERZBERG, Vice-President  
 I. S. MANHEIMER, Secretary

R. D. WASHBURNE,  
 Technical Editor



HUGO GERNSBACK, Editor-in-Chief

JOHN F. RIDER,  
 Editor Service Dept.

C. P. MASON,  
 Associate Editor

VOLUME II  
 NUMBER 4

## Contents of This Issue

OCTOBER  
 1930

	PAGE		PAGE
<b>EDITORIAL:</b>			
More Money for the Radio Service Man		NEW DEVELOPMENTS IN RADIO:	
By Hugo Gernsback	199	The "Stenode Radiostat" .....	By Clyde J. Fitch 210
<b>SERVICE MEN'S DEPARTMENT:</b>			
What the Service Man Should Know.....	By John F. Rider 200	Television in Twelve Colors.....	By Dr. Fritz Noack 212
Leaves from Service Men's Notebooks		Men Who Have Made Radio (XIII) — Count Georg	
By RADIO-CRAFT Readers	201	von Arco .....	213
The Service Man's Open Forum.....	202	New Radio Devices for Shop and Home.....	223
Servicing Automotive Radio.....	By J. Kenneth Windley 203	Review of Recent Radio Literature.....	223
Modernizing the Freshman Masterpiece..	By E. C. Hubert 204	Radio's Greatest Debt.....	By H. B. Richmond 241
What is a Reliable Tube Test.....	205	<b>SHORT-WAVE CRAFT:</b>	
<b>RADIO SERVICE DATA SHEETS:</b>			
Kolster K-20, K22, K25, K27 and K37.....	206	The Short-Wave Superheterodyne.....	By L. W. Hatry 214
Columbia Screen-Grid Eight.....	207	The "Universal" Broadcast Receiver.....	By Samuel Whisk 216
The Junior Service Man.....	By L. H. Houck 208	Short-Wave Notes .....	248, 251
Operating Notes for Service Men.....	By Bertram M. Freed 209	<b>CONSTRUCTIONAL AND EXPERIMENTAL:</b>	
Simple Mathematics for the Service Man (Part II)		A Public-Address Adapter Unit.....	By Howard Smith 218
By Boris S. Naimark	234	RADIO-CRAFT Kinks .....	220
What Power Does a Receiver Use?.....	236	A Powerful Two-Volt Screen-Grid Receiver	
Resistor Replacement Rejuvenates Old Sets		By H. G. Cisin	221
By Francis R. Ehle	240	Running Your Radio for "Nothing".....	By A. T. Brown 222
		RADIO-CRAFT's Information Bureau .....	224
		Reception Without a "B" Battery.....	251

### In Forthcoming Issues

**AUTOMATIC VOLUME CONTROLS**, by C. H. W. Nason.  
 The automatic volume control is one of the most noteworthy commercial developments of the past year, and should attract the attention of all who wish to keep up with the times, Mr. Nason not only explains the operation of the device, but gives constants for building units for use with previous receiver models, or incorporation in sets to be built.

**THE BUSINESS SIDE OF SERVICING**, by George K. Graham. While this magazine is devoted primarily to the technique of radio, the radio Service Man should welcome

any article which will show how to make his knowledge more profitable. We found this article very interesting from this standpoint, and so will every wide-awake radio man.

**APPLICATIONS OF PHOTOELECTRIC CELLS.** The recent ingenious applications of photo cells to commercial and industrial purposes assume great practical importance; and the radio Service Man will be interested in the articles which explain these new vacuum-tube operated devices. And many other articles on subjects of practical interest to the radio man.

RADIO-CRAFT is published monthly, on the fifth of the month preceding that of date; its subscription price is \$2.50 per year. (In Canada and foreign countries, \$3.00 a year to cover additional postage.) Entered at the postoffice at Mt. Morris, Ill., as second-class matter under the act of March 3, 1879. Trademarks and copyrights by permission of Gernsback Publications, Inc., 98 Park Place, New York City.

Text and illustrations of this magazine are copyright and must not be reproduced without permission of the copyright owners. We are also agents for WONDER STORIES, AMAZING DETECTIVE TALES and WONDER STORIES QUARTERLY. Subscriptions to these magazines may be taken in combination with RADIO-CRAFT at reduced Club rates. Write for information.

Copyright 1930. GERNSBACK PUBLICATIONS, INC.

Published by  
**TECHNI-CRAFT PUBLISHING CORPORATION**

Publication Office: 404 No. Wesley Ave., Mount Morris, Illinois

Editorial and Advertising Offices  
 96-98 Park Place, New York City

Western Advertising Office  
 737 North Michigan Avenue, Chicago, Ill.

L. F. McCLURE, Western Advertising Representative

London Agent: Hachette & Co.,  
 16-17 King William St., Charing Cross, W.C. 2

Paris Agent: Hachette & Co.,  
 11 Rue Reaumur

Australian Agent: McGill's Agency,  
 179 Elizabeth St., Melbourne

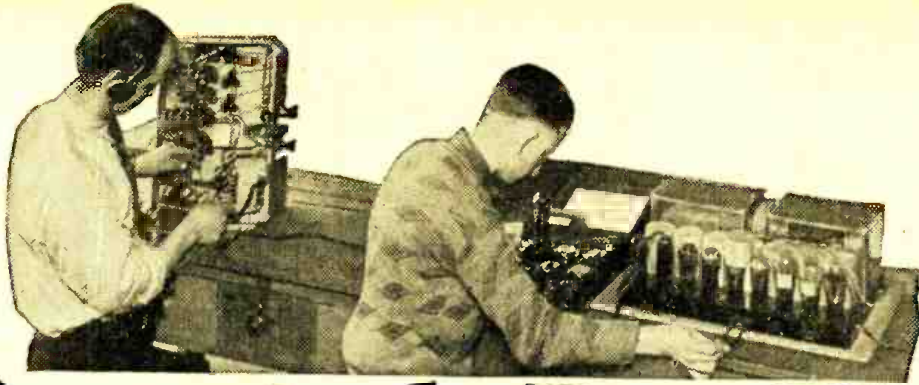

# Amazingly Easy Way to Learn RADIO-TELEVISION TALKING PICTURES

Don't spend your life slaving away in some dull, hopeless job! Don't be satisfied to work for a mere \$20 or \$30 a week. Let me show you how to make REAL MONEY IN RADIO—THE FASTEST-GROWING, BIGGEST MONEY-MAKING GAME ON EARTH!

**Thousands of Jobs Open Paying \$60, \$70 to \$200 a Week**

Jobs as Designer, Inspector and Tester paying \$3,000 to \$10,000 a year—as Radio Salesman and in Service and Installation Work, at \$45 to \$100 a week—as Operator or Manager of a Broadcasting Station, at \$1,800 to \$5,000 a year—as Wireless Operator on a Ship or Airplane, as a Talking Picture or Sound Expert—THOUSANDS OF JOBS PAYING \$60, \$70 AND ON UP TO \$200 A WEEK!

## *Learn Without Lessons in 60 Days* By Actual Work—In the Great Coyne Shops

You learn ALL branches of Radio at Coyne—in 8 short, pleasant weeks—NOT BY CORRESPONDENCE, but by actual work on actual Radio, Television and Sound equipment. We don't waste time on useless theory. We give you just the practical training you'll need—in 8 weeks' time.

### **No Books-No Lessons**

**All Practical Work at Coyne**

Coyne is NOT a Correspondence School. We don't teach you from books or lessons. We train you on the greatest outlay of Radio, Television and Sound equipment in any school—on scores of modern Radio Receivers, huge Broadcasting equipment, the very latest JENKINS Television apparatus, Talking Picture and Sound Reproduction equipment, Code Practice equipment, etc. You don't need advanced education or previous experience. We give you—right here in the Coyne Shops—all the actual practice and experience you'll need.

### **TELEVISION is on the way**

And now Television is on the way! Soon there'll be a demand for THOUSANDS of TELEVISION EXPERTS! The man who learns Television NOW can make a FORTUNE in this great new field. Get in on the ground-floor of this amazing new Radio develop-

H. C. Lewis, Pres. **Radio Division** Founded 1899  
**COYNE ELECTRICAL SCHOOL**  
500 S. Paulina St., Dept. 70-5B, Chicago, Ill.

ment! Learn Television at COYNE on the very latest JENKINS Television equipment.

### **Talking Pictures a Great Field**

Talking Pictures and Public Address Systems offer thousands of golden opportunities to the Trained Radio man. Here is a great new field of Radio that has just started to grow! Prepare NOW for these marvelous opportunities! Learn Radio Sound Work at Coyne, on actual Talking Picture and Sound Reproduction equipment.

### **COYNE IS 31 YEARS OLD**

Don't worry about a job! Coyne Training settles the job question for life. You get Free Employment Help as long as you live. And if you need part-time work while at school to help pay expenses we'll gladly help you get it. Coyne is 31 years old! Coyne Training is tested—proven beyond all doubt. You can find out everything absolutely free. JUST MAIL COUPON FOR MY BIG FREE BOOK.

H. C. LEWIS, PRESIDENT

**Radio Division, Coyne Electrical School**  
500 S. Paulina St., Dept. 70-5B, Chicago, Ill.

Send me your Big Free Radio Book and all details of your Special Introductory Offer. This does not obligate me in any way.

Name .....

Address .....

City..... State.....

# for . . . Dependability

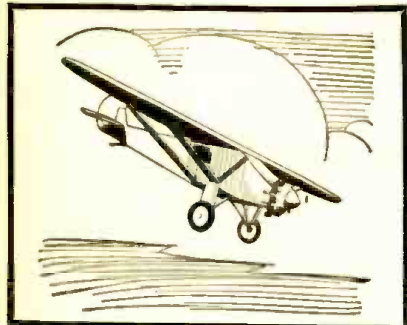

Up in the air—flying across great open stretches of sea to the little Isle of Bermuda, making a world record and keeping in touch with the world every minute of the day and night with a Pilot Super-Wasp Set, relying all the time on the Dependability of Pilotron Radio Tubes.

« « «

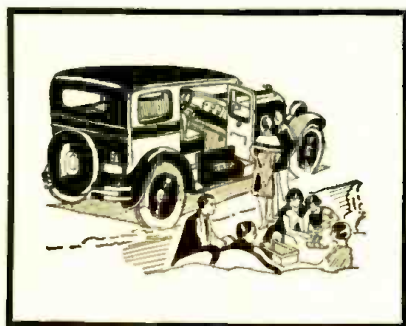

Camping miles from anywhere—enjoying some favorite program with your Auto-Pilot Screen Grid receiver and knowing that you can depend on your Pilotron Radio Tubes under all conditions.

« « «

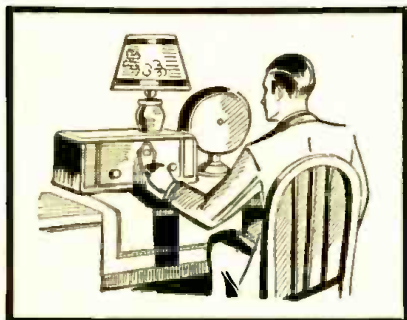

The Professional operating on world wide reception—keen and alert, must avoid confusing tube noises—crackles and distortion—and with dependable Pilotron Radio Tubes in every socket he enjoys the thrill of “pulling in” messages from far away.

« « «

You too—under all conditions—on any set will appreciate the difference that dependable Pilotron Radio “long life” Tubes give to the reception of radio broadcast programs.

# PILOTRON

## RADIO



## TUBES

### ENDORSED BY PROFESSIONALS

LICENSED BY RCA

### PILOT RADIO & TUBE CORP.

FACTORIES AT LAWRENCE, MASS.

Chicago Office: 234 South Wells St.

San Francisco Office: 1278 Mission St.

Here are a few examples of the kind of money I train "my boys" to make

Started with \$5. Now has Own Business



"Can't tell you the feeling of independence N.R.I. has given me. I started in Radio with \$5, purchased a few necessary tools, circulated the business cards you gave me and business picked up to the point where my spare time earnings were my largest income. Now I am in business for myself. I have made a very profitable living in work that is play."

HOWARD HOCSTON,

512 So. Sixth St., Laramie, Wyo.

\$700 in 5 Months Spare Time

"Although I have had little time to devote to Radio my spare time earnings for five months after graduation were approximately \$700 on Radio sales, service and repairs. I owe this extra money to your help and interest. Thanks for the interest shown me during the time I studied and since graduation."



CHARLES W. LINSEY,  
537 Elati St., Denver, Colo.

\$7396 Business in two and one-half Months



"I have opened an exclusive Radio sales and repair shop. My receipts for September were \$2332.16—for October, \$2887.77 and for the first half of November, \$2176.32. My gross receipts for the two and one-half months I have been in business have been \$7396.25. If I can net about 20% this will mean a profit of about \$1500 to me."

JOHN F. KIRK,

1514 No. Main St., Spencer, Iowa.

My Free book gives you many more letters of N. R. I. men who are making good in spare time or full time businesses of their own



Rear view of 5-tube Screen Grid Tuned Radio frequency set — only one of the many circuits you can build with my parts.

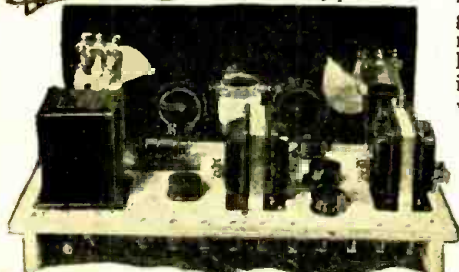

You'll get practical Radio Experience with my new 8 Outfits of Parts that I'll give you for a Home Experimental Laboratory!

My course is not all theory. You use the 8 Outfits I'll give you, in working out the principles, diagrams and circuits used in modern sets and taught in my lesson books. This 50-50 method of home training makes learning easy, fascinating, interesting. You get as much practical experience in a few months as the average fellow who hasn't had this training gets in two to four years in the field. You can build over 100 circuits with these parts. You experiment with and build the fundamental circuits used in such sets as Crosley, Atwater-Kent, Eveready, Majestic, Zenith, and many others sold today. You learn how these circuits work, why they work, how they should work, how to make them work when they are out of order.

I will show You too how to start a spare time or full time Radio Business of Your Own without Capital



J. E. Smith, Pres., National Radio Institute

The world-wide use of receiving sets for home entertainment, and the lack of well trained men to sell, install and service them have opened many splendid chances for spare time and full time businesses. You have already seen how the men and young men who got into the automobile, motion picture and other industries when they were young had the first chance at the key jobs—and are now the \$5,000 \$10,000 and \$15,000 a year men. Radio offers you the same chance that made men rich in those businesses. Its growth is opening hundreds of fine jobs every year, also opportunities almost everywhere for a profitable spare time or full time Radio business. "Rich Rewards in Radio" gives detailed information on these openings. It's FREE.

So many opportunities many make \$5 to \$30 a week extra while learning

Many of the ten million sets now in use are only 25% to 40% efficient. The day you enroll I will show you how to do ten jobs common in most every neighborhood, that you can do in your spare time for extra money. I will show you the plans and ideas that are making as high as \$200 to \$1,000 for others while taking my course. G. W. Page, 107 Raleigh Apts., Nashville, Tenn., writes: "I made \$935 in my spare time while taking your course."

Many \$50, \$60 and \$75 a week jobs opening in Radio every year

Broadcasting stations use engineers, operators, station managers, and pay \$1,800 to \$5,000 a year. Radio manufacturers continually need testers, inspectors, foremen, engineers, service men, and buyers for jobs paying up to \$15,000 a year. Shipping companies use hundreds of operators, give them world-wide travel at practically no expense and pay \$85 to \$200 a

month. Radio dealers and jobbers are continually on the lookout for good service men, salesmen, buyers, managers, and pay \$30 to \$100 a week. Talking Movies pay as much as \$75 to \$200 a week to the right men with Radio training. My book tells you of other opportunities in Radio.

I will train you at home in your spare time

Hold your job until you are ready for another. Give me only part of your spare time. You don't have to be a high school or college graduate. Hundreds have won bigger success. J. A. Vaughn jumped from \$35 to \$100 a week. E. E. Winborne seldom makes under \$100 a week now. The National Radio Institute is the Pioneer and World's Largest organization devoted exclusively to training men and young men, by correspondence for good jobs in the Radio industry.

You Must Be Satisfied

I will give you an agreement to refund every penny of your money if you are not satisfied with my Lessons and Instruction Service when you complete my course. And I'll not only give you thorough training in Radio principles, practical experience in building and servicing sets, but also train you in Talking Movies, give you home experiments in Television, cover thoroughly the latest features in sets such as A. C. and Screen Grid.

My 64-Page Book Gives the Facts

Clip and mail the coupon now for "Rich Rewards in Radio." It points out the money-making opportunities the growth of Radio has made for you. It tells of the opportunities for a spare time or full time Radio business of your own, the special training I give you that has made hundreds of other men successful; and also explains the many fine jobs for which my course trains you. Send the coupon to me today. You won't be obligated in the least.

Get my new book It points out what Radio Offers You



J. E. SMITH, President  
Dept. OLY.  
National Radio Institute  
Washington, D. C.

THIS COUPON IS GOOD FOR ONE FREE COPY OF MY NEW BOOK

mail it TODAY

J. E. SMITH, President,  
National Radio Institute, Dept. OLY,  
Washington, D. C.

DEAR MR. SMITH:—Send me your book. I want to see what Radio offers. I understand this request does not obligate me and that no agent will call.

Name.....

Address.....

City..... State.....

Get the facts on my Lifetime Employment Service to all Graduates

# Announcement!



## NATIONAL RADIO SERVICE MEN'S ASSOCIATION

### BOARD OF DIRECTORS

- L. M. Cockaday*
- David Grimes*
- John F. Rider*
- Hugo Gernsback*
- Sidney Gernsback*
- I. S. Manheimer*

**E**VER since the appearance of the commercial radio broadcast receiver as a household necessity, the Radio Service Man has been an essential factor in the radio trade; and, as the complexity of electrical and mechanical design in receivers increases, an ever-higher standard of qualifications in the Service Man becomes necessary.

The necessity, also, of a strong association of the technically-qualified radio Service Men of the country is forcing itself upon all who are familiar with radio trade problems; and their repeated urgings that such an association must be formed has led us to undertake the work of its organization.

This is the fundamental purpose of the NATIONAL RADIO SERVICE MEN'S ASSOCIATION, which is not a money-making institution, or organized for private profit; to unite, as a group with strong common interests, all well-qualified Radio Service Men; to make it readily possible for them to obtain the technical information required by them in keeping up with the demands of their profession; and, above all, to give them a recognized standing in that profession, and acknowledged as such by radio manufacturers, distributors and dealers.

To give Service Men such a standing, it is obviously necessary that they must prove themselves entitled to it; any Service Man who can pass the examination necessary to demonstrate his qualifications will be elected as a member and a card will be issued to him under the seal of this Association, which will attest his ability and prove his identity.

The terms of the examination are being drawn up in co-operation with a group of the best-known radio manufacturers, as well as the foremost radio educational institutions.

The following firms are co-operating with us:

- GRIGSBY-GRUNOW CO (Majestic), CHICAGO
- STROMBERG-CARLSON TELEPHONE MFG. CO., ROCHESTER, N. Y.
- CROSLEY RADIO CORP., CINCINNATI, OHIO
- COLIN B. KENNEDY CORP., SOUTH BEND, IND.

The schools who have consented to act as an examination board are:

- International Correspondence Schools, Scranton, Penna.; Mr. D. E. Carpenter, Dean.
- RCA Institutes, Inc., New York, N. Y.; Mr. R. L. Duncan, President.
- Radio & Television Institute, Inc., Chicago, Ill.; Mr. F. G. Wellman, Managing Director.
- Radio Training Association of America, Chicago, Ill.; Mr. A. G. Mohaupt, President.
- School of Engineering of Milwaukee, Milwaukee, Wisc.; Mr. W. Werwath, President.
- Rider-Goll Radio School, New York, N. Y.; Mr. John F. Rider, Director.
- Radio College of Canada, Toronto, Canada; Mr. J. C. Wilson, President.
- Radio Division, Coyne Electrical School, Chicago, Ill.; Mr. H. C. Lewis, President.

We shall not attempt to grade the members into different classes. A candidate will be adjudged as either passing or not passing. If the school examining the papers passes the prospective member as satisfactory, we shall issue to him an identification card with his photograph.

If the candidate does not pass this examination the first time, he may apply for another examination three or six months later.

There is absolutely no cost attached to any service rendered by the Association to its members, no dues, no contributions.

If you wish to become a member, just fill out the coupon below and mail it to us. We will send you all the papers necessary to become a member.

N. R. S. M. A.,  
c/o RADIO CRAFT,  
98 Park Place,  
New York, N. Y.

I wish to become a member of your Association. Please mail me the examination papers and application blanks.

Name .....

Address .....

Town..... State.....





OCTOBER  
1930  
VOL. II—No. 4



HUGO GERNSBACK  
Editor

“Takes the Resistance Out of Radio”

## More Money for the Radio Service Man

By Hugo Gernsback

**D**ESPITE the fact that we hear on every hand that the economic conditions are at low ebb, at present, there is still a good deal of money to be made by the wide-awake radio man. Every cloud has its silver lining. The very fact of the depression, paradoxical as this sounds, helps the industrious radio man during the next few months; and he will be enabled to cash in on this situation, perhaps more so than during any other season.

A conservative estimate, from reliable sources, places the number of battery-operated receivers still in use, in this country, considerably over 5,000,000. While practically all of them are today hopelessly out of the running, when we compare them with the present-day A.C. models, many of these old battery sets still give satisfactory, even excellent reproduction; although they are a nuisance to their owners, as far as the battery end is concerned.

Of the 5,000,000 battery sets, it is safe to say that considerably over 70 per cent. are in homes which are wired for A.C. current; and a small percentage of other homes are supplied with D.C. current.

These battery sets are being replaced, little by little, by up-to-date power sets; but, as in everything else, the process is slow and gradual. Particularly in this season, in view of the existing economic conditions, it is doubtful whether any great percentage of radio owners will change over, from battery sets to A.C. operation, by investing in new sets.

The chances are that the vast majority of the owners of battery-operated sets will try to worry along with their present receivers, rather than go to the expense of buying the latest models. And it is here that the opportunity of the radio man comes in.

There are on the market, today, any number of low-priced power packs which can be bought cheaper now than at any time during the past and are, without a question of a doubt, much cheaper right now than they will ever be again. The reason is that very few new power packs are now built; while those on the market are, in many instances, really distress merchandise. Of course, there are some new packs manufactured (to which we, personally, would give the preference if we had to do the job); but the drawback of these, at the present time, is that they run into quite a sum of money and, except where the owner of a battery-operated set has quite an expensive model, from which he does not wish to part, it will as a rule be difficult to make a sale of an installation incorporating a newly-manufactured power pack.

The wide-awake radio man, who wishes to cash in on the situation outlined above, should find out how many battery-operated sets there are in his community, and how many of them are in homes where electric current exists. This should not be difficult to find out; and even a house-to-house canvass during the dull season might bring in a handsome harvest.

The radio man should explain to the set owner that, for a reasonable amount of money, it is now possible to convert his battery set to an excellent A.C.- (or D.C.-) operated set, doing away with both storage batteries and “B” batteries. Of course, there are any number of sets on the market that use “eliminators”

of one kind or another; and it may be stated that most of these “eliminators” today are anachronisms. They require constant care and usually contain an acid solution, that has ruined many a good rug and woodwork. With the modern power pack all this is done away with; and the talking points on the power pack are so great that, if the set owner is made to realize what it is all about, he will usually consent to have the set converted for power operation.

In the large majority of cases, it is possible to install the power pack right into the cabinet. In many of these the present space is sufficient, since the power packs do not take up much room; this is particularly true of the console set. If, however, the power pack cannot be put into the set itself, it may of course be placed inside a small box or small cabinet underneath the table, desk, in a closet or elsewhere. Inasmuch as the power pack does not give off much heat, to speak of, it may safely be placed even in the vicinity of woodwork, such as on shelves, etc., where proper ventilation is afforded.

Of course, a change-over to electric operation necessitates also the purchase of a number of new tubes and in this the radio man will cash in too; as, no doubt, the owner will be willing to buy the tubes from him.

While a battery set thus converted may not be as good as a modern set designed for A.C. operation, yet it will do the work satisfactorily and certainly as well, if not better, than the original battery set. Incidentally, the radio man will get the good will of the owner and, when economic conditions change, which they always do sooner or later, the set owner will be a good sales prospect for a modern set. And, as every radio man realizes, it is the long pull that counts. Once you get the good will of the community or the neighborhood, the rest will be easy; and a steady income is assured.

I have mentioned several ways to approach the prospect, and I wish here to add several other methods.

In the city, in apartment houses the easiest way to get information is from the janitor or superintendent. Usually a cigar will do the trick, and the names of the set owners can be had readily. Personal solicitation of the set owners is then not necessary. The thing can be accomplished best either by a telephone call in the evening, when the owner is home; or otherwise by letter, although the telephone method is the best.

In the country the conditions are somewhat simpler because information as to who has a set is easier to get and practically every radio man knows his prospects or can easily get a list. Here again the telephone system is the best to get the owner's attention which, when followed up by personal solicitation, should net quite a few orders.

In every case, it is most important that the set owner be informed that, by converting his set from battery to power operation, he will get (as a rule) much better results as to volume, and he will be saved the bother of batteries. If the radio man can prepare a little calculation, showing that the change-over will actually save its cost in operating expenses within six months or less, the set owner can usually be sold on the idea of having the change made immediately.

# Service Men's Department

*This department is about the Service Man, for the Service Man, and largely by the Service Man. Its contributors are practical men, and we invite every Service Man in the country to tell about his own experiences of all kinds.*

Edited by JOHN F. RIDER

## WHAT THE SERVICE MAN SHOULD KNOW

By John F. Rider

A GOOD deal of agitation can be caused by the misunderstanding of a few simple words. Take, for example, the present discussion about mathematics for the Service Man. Many individuals have advocated studies of varied sorts for the practicing Service Man, and among the suggestions has been advanced mathematics. Just how much mathematics does the Service Man require? Does he need to study that subject at all?

In order to reply to the above questions, it is first necessary to analyze the function of the Service Man. Primarily, his work consists of an effort to restore a defective receiver to its original state of high electrical efficiency; this is repair work pure and simple. However, many other fields of activity have been suggested for the Service Man; the most prominent of which is sound installation—the installation of public-address systems and of remote control. Hence we must, of necessity, segregate such work into two categories: (1) maintenance service; and (2) design work. We apply the word design to the installation of sound systems and kindred work; because each installation is in a class by itself, presents its own complications and requires individual solution.

As to repair work, we must realize that the term "repair" is not adequate to describe the efforts necessary to maintain successful operation; it is not a true expression of the duties involved but, for the want of a better term, we shall henceforth designate all repair as maintenance. Repair maintenance is carried out along certain lines. While the extent of the equipment employed is not definite, the subject and the object are concrete items; the first is a defective receiver, and the second is its restoration to its original electrical condition. With any one receiver at hand, no matter how many the number of faults, the work necessary comprises diagnosis of the trouble, location of the defective part or system, and finally replacement.

With respect to the diagnosis of trouble, we have three states: the first is a unit irreparably damaged; the second is an incorrect device; and the third is an incorrect operating condition or adjustment. Assuming correct diagnosis, rectification of the first state means the replacement of the defective device with another (invariably available from some source or other, since that receiver is a commercial product and replacement parts can be secured). Remedy of the second state, once again, entails re-

## IMPORTANT NEXT MONTH

RADIO-CRAFT will appear in an entirely new dress. If you are a newsstand reader, *watch for it*. The cover design and make-up will be changed materially. The series "Men Who Have Made Radio," featured on our front cover for over one year, closes with this issue. Watch for the new cover, on the next number of

## "RADIO'S LIVEST MAGAZINE"

placement with the correct device originally designed for that part of the receiver system. The use of the incorrect device is due to an error on the part of some particular individual, and can be corrected in a simple manner. The third state is somewhat more complicated; in that it is necessary first to know the proper operating condition and, in the second place, to make the needed corrections, be they mere adjustments or more tedious replacement.

If we first concern ourselves with the replacement problem, the possibility of extensive calculations, of one sort or another, on the part of the Service Man is entirely lacking. It is true that it is frequently necessary to determine the correct value of resistance necessary to produce a certain voltage drop in the plate circuit, the filament circuit or the grid circuit; but we feel safe in stating that such work is neither laborious nor does it involve higher mathematics. If the unit desired is a fixed capacity which is damaged, computation is obviated by reference to general text matter, wherein may be found the average values of capacity employed in different parts of a radio receiver. As a matter of fact, the experienced Service Man need not spend much time ascertaining the capacity value suitable as a by-pass unit in the plate cir-

cuit of a detector tube, across a voltage-divider section, in the plate circuit of an R.F. amplifier tube, etc. All radio receivers, commercial and otherwise, bear a distinct resemblance to each other. While the exact design of the receiver may differ from the usual, there is a great deal of similarity in by-pass circuits, as to the values of the radio-frequency chokes and of the by-pass capacity. Hence, extensive calculation on this score is unnecessary.

If we proceed to inductances and variable capacities suitable for tuning, few Service Men take upon themselves to replace a tuned radio-frequency transformer, which has been found defective, with one of their own manufacture. The design of the modern radio receiver is quite critical, particularly when tuned radio-frequency transformers and their associated tuning capacities must be replaced. The most logical solution is replacement with another coil or set of coils, or another tuning capacity or a gang of condensers, secured from the manufacturer. Once again, the need for extensive computation is absent.

Proceeding further in the receiver, the replacement of defective audio-frequency transformers, choke coils, coupling resistors and output transformers does not require calculation on the part of the Service Man. All of the design considerations have been taken care of by the manufacturing organization and its engineering personnel. Thus, the need for a mathematical education is not apparent while carrying on certain forms of Service Work.

Now, as to correction or adjustment of operating conditions, such work must conform with certain definite specifications, either those secured from the manufacturer who made the receiver or those of the manufacturer who made the tubes. In either case, the adjustments are made according to the indications upon testing devices, such as voltmeters and current meters. Contact of such type when adjusting a radio receiver seldom necessitates the introduction of additional resistances in order to secure the correct operating potential. It means, no doubt, the adjustment of a variable-tap resistor or the changing of the tap contacts, but seldom the removal of one resistor and the insertion of an entirely different component which would necessitate computation of the currents and voltages in a system. The only possible work where computation may be necessary is the readjustment of an output circuit to accommodate a new lot of loud speakers or to provide for the addition of speakers. Under the circumstances it is difficult to find the occasion

(Continued on page 227)

# Leaves from Service Men's Note Books

The "Meat" of what our professionals have learned by their own practical experiences of many years

By RADIO-CRAFT READERS

## AN A.C.-OPERATED SERVICE OSCILLATOR

By W. R. Wheatley

NO doubt, every radio experimenter and Service Man has many times wished for a small portable generator of signals of various frequencies, either modulated or unmodulated. I have constructed one which is exceptionally compact, obtains its power supply by simply plugging into the light socket, and covers a wide range of frequencies with three plug-in coils. It comprises a '27 tube used as an oscillator, in the conventional tuned-grid circuit, and an '01A tube with grid and plate tied together as rectifier.

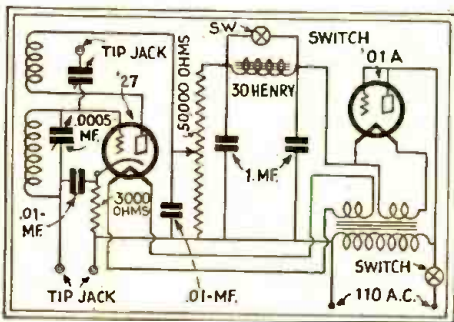

Mr. Wheatley's oscillator, with a home-made power transformer, is an extremely compact and convenient device, modulated by the A.C. hum of the light line. A jumper is put across the lower tip jacks when the meter is not in circuit.

One 30-henry choke is used in the filter circuit, which is conventional; the voltage divider is a 50,000-ohm potentiometer, with the plate of the '27 connected to the slider, so that a variable voltage is provided for the plate of the oscillator. The filament supply of the two tubes is from a transformer, and the plate voltage is taken direct from the 110-volt A.C. line; as this supplies voltage high enough for the purpose after it is rectified. Tip jacks are provided in the grid-return circuit, so that a meter may be plugged in to be used in lining up gang condensers or testing the resonance of circuits. A small variable condenser is provided, with one side connected to the grid and the other to a tip jack; so that the oscillator is easily coupled to other circuits.

This oscillator is very handy for lining up gang condensers and neutralizing sets; I have used it as the oscillator in a superhet. An ordinary set can be converted to a super by connecting the grid of the first tube to an external tuned circuit coupled to the oscillator. Although a very slight A.C. ripple remains in the voltage supply of the oscillator, when the signal of the oscillator is tuned in on a sensitive receiver it appears about the same as the A.C. hum in ordinary receivers.

In order to modulate the signal sufficiently, so that it may be heard distinctly, a switch

is connected across the 30-henry choke. When closed, this modulates the signal with the 60-cycle hum which is very distinct. The schematic diagram shows all details.

However, when I looked for a filament transformer I was unable to find one small enough; so I constructed one. I used the core iron from a 30-henry choke, and also the form on which the wire was wound; on this I wound 1200 turns of No. 28 enameled wire for the primary. Over this were 28 turns of No. 18 D.C.C. wire for the 2 1/2-volt secondary, and over this 55 turns of No. 20 D.C.C. wire for the 5-volt secondary. Although this transformer becomes warm when in operation, I have operated several hours without undue heating.

To illustrate the compactness of this oscillator, the panel is 7 inches wide by 9 inches long, and the entire apparatus underneath the panel is housed in a wooden box the size of the panel and 3 1/2 inches deep. The broadcast coil covers from 530 to 1700 kilocycles. The other two coils I have not had time to calibrate as yet but they reach as far as the shortest wavelength stations I have been able to get.

## CONDENSER REPLACEMENTS

By Paul L. McCoun, W9EHB

WHEN you find a Majestic or Atwater Kent with a shorted or open condenser in the power pack, do you put in a new condenser bank? It lists for \$17.50 in the Majestic; and in most Atwater Kent models there is no provision for replacing the bank, the idea being to send back the whole pack. Usually the customer talks of buying a new receiver—of some other make.

It is better practice for the Service Man to repair the old set—both from the standpoint of profit and of the customer's good will. However, this must be done at a reasonable cost.

You do not have to open the Majestic con-

denser bank; here is the secret. Under the rectifier socket there is space enough for two 2-mf. condensers of certain makes—such as the Tobe "300" series. The highest load is 220 volts, and a rating of 300 is probably safe. The value of the defective condenser may be determined; if a 3-mf. section is out, use a 2-mf. and a 1-mf. replacement in parallel. It is a simple matter to cut out the ruptured section and connect the new condenser in its stead. Do not operate the pack without a normal load; the voltage then rises to 400!

In the Atwater Kent Model 40, the transformer, chokes and condenser are sealed in a sheet iron container, just a bit too formidable for the best can opener. The condensers and speaker choke are in the end opposite the rectifier socket. After determining that the condensers are at fault, remove the pack from the set and take off the terminal board on top. Procure a hammer and a six-inch cold chisel; wedge the latter between the base and sides of the pack at the condenser end, and use the hammer. The base is spot-welded to the sides of the can; cut the spots until the base is loose. Double it back upon itself and, with a piece of 2 x 2 for a punch, drive out the right-hand section of the pack from the bottom. Before you drive it clear out, cut any wires that do not break readily; they are on the top side just underneath the wax. With a small hammer crack the wax off the choke and condensers; it will be a sorry-looking mess. That funny-looking hedgehog affair is the speaker choke; save it.

It is possible to salvage part of the condensers; but not advisable, especially if you batter them badly in removal.

There are two alternatives: obtain a condenser-and-choke unit, for some of the later models of the "40," which were made with these components in a removable can, and with the same wiring code; or replace the condensers with others of suitable values. I

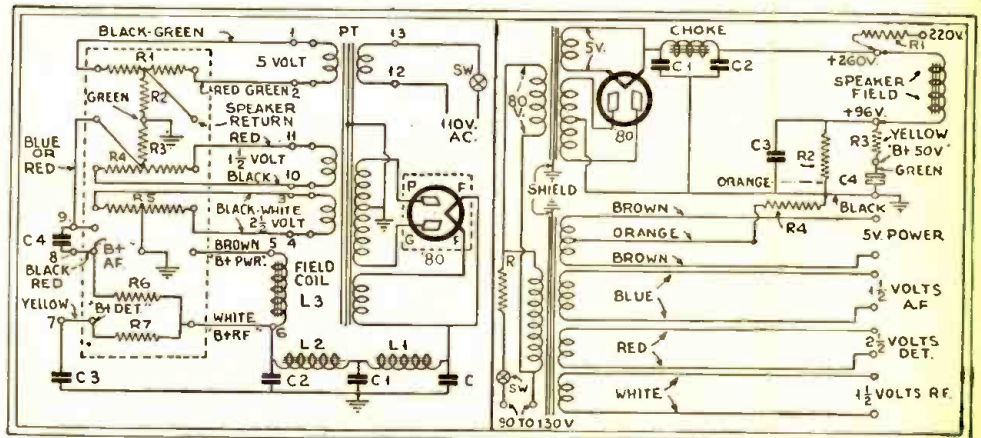

At the left, the A.K. "Model 40" power pack; there are minor changes in the units of the 37, 38, 42, 44, and 52, and the color code is not the same in all. At the right, the Majestic "7BP6:" C1, 2 mf.; C2, 3 mf.; C3, 3 mf.; C4, 2 mf. In the "7P6-7P3" they are respectively 2, 6, 2 and 2 mf.; in the "7BP3," 3, 4, 3 and 3. R1 is 1000 ohms, and the speaker field resistance is 2730 ohms.

have found these suitable: first filter condenser connected to the green lead with yellow tracer and the ground, 1-mf.; second, to green wire and ground, 1-mf.; third filter condenser, to red wire and ground, 2-mf. The by-passes on the detector and the first audio resistors are 0.5-mf.; the latter to the center tap of the 1½-volt winding. The speaker choke connects between the red lead above mentioned and the second terminal at the right (rear).

If the first audio or the detector by-pass is damaged, disconnect it at the terminal board and place a small by-pass condenser in the top of the pack to replace it.

### HINTS ON RADIOLA SERVICING

By "Major" Budenkaye

I HAVE witnessed instances where Service Men all but committed suicide over some cases where sets lack volume, especially when they are located several hundred miles from the big broadcast stations. Sometimes a condition like this will be found in a Radiola of the 17, 18, 33, and 41 series, when everything tests O. K.

The first thing to do is to sandpaper the lugs on the R.F. coils—even though an ohmmeter test says they are O. K. Be sure to get enough enamel off the wire leading to the lug so that you can get enough solder on it.

A hint that may be useful is to turn the chassis upside down while it is in working condition, tuned to a station; so that no time will be lost if a defect is found. (The shocks will fall to Service Men of the type who do not know, as they should, where the high-voltage leads are.)

After resoldering the coil lugs, procure from an Atwater Kent distributor part No. 13,482: this is a small pancake coil, about an inch and a half in diameter, with three connections. One end, which is identified by a pigtail, is to be connected to the grid terminal of the first R.F. socket. Disconnect all the wires from the volume control and wire leading to the grid terminal of the socket. On one side of volume control are four ground wires; after disconnecting

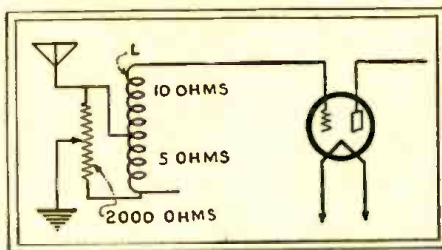

This suggestion is a kink to improve the antenna coupling of certain Radiola models, where volume is lacking under rural conditions, by substituting a standard part used in another well-known line.

them, solder them together and tape. Take the A. K. (antenna) coil and mount it as near as possible to the first R.F. socket. There are three bolts through the chassis to hold the bathtub condenser assembly; one of these is about two inches away from the first socket, and the coil may be mounted on this. The pigtail of the coil should be soldered to the blank grid terminal clip of the socket; the middle lead to the aerial connection, and the third lead to the ground wire, completing the connection of the coil.

We have the volume control disconnected; there are several ways of utilizing it. If there are one or two broadcast stations near, the best procedure is to shunt it between aerial and ground. If the locality is free from broadcast interference, hook it up across the primary of the first or second R.F. coil. Make the leads as short as possible and keep them away from other leads and parts; the same observation applies to the antenna coil.

After this, test the set; it probably will tend to oscillate at about 250 meters. If it has an R.F. compensating condenser, adjust this until oscillation ceases. If it has not (Radiola 17, 41 or 50) bend the plates in or out on one of the rotors of the condenser assembly.

If you run across a Radiola of the 60 or 62 series, pay special attention to the plate voltage of the first detector and oscillator; if this is less than 75, replace the brown resistor (marked 14,300 ohms) in the power pack.

If there is a drop in plate voltages in all the sockets, though the rectifier is O. K., change the bleeder resistor. This should have a resistance of 20,000 ohms, but if it starts to go bad, its resistance decreases instead of increasing; it is placed across the 135-volt portion of the "B" unit to protect the units in the circuit against the unduly high voltages which would occur if a number of tubes were removed from the set, or some part should break down.

In this series, abnormal hiss with proper operation may be traced to small defects in carbon- and -porcelain resistors. In the  
(Continued on page 227)

## The Service Man's Open Forum

### SHOULD THE SERVICE MAN BE AN ELECTRICIAN?

Editor, RADIO-CRAFT:

I do not agree with Mr. W. J. Saunders, of Merom, Ind., whose letter appeared in the July issue of RADIO-CRAFT. To be a competent Service Man, I believe it is not necessary to be a licensed electrician. The latter has to learn all about house wiring, power wiring, motors and generators, etc.; but what has that to do with a small radio set? Even if *The Electrical Contractor* did print that radios were the third cause of fires in New York City, I do not think the Service Man can be blamed; for hundreds of sets are installed by the purchaser, and a Service Man doesn't even enter the picture. Mr. Saunders is an electrical contractor and, from my experience, the average electrician doesn't know a whole lot about radio.

I have built and serviced radio receivers ever since the first broadcast station went on the air; and I have never found it necessary to use algebra, geometry, or trigonometry in servicing a single receiver.

I don't know a thing about a single one of these subjects; of course, the engineers and designers of receivers must have a thorough knowledge of them; but, to shoot trouble, it is not necessary.

What does the average licensed electrician know about tubes, cathode volts, grid bias, etc? Can he explain the action of a vacuum

tube when used as an oscillator, an amplifier or a detector? Can he take a set analyzer and test a receiver thoroughly and know what the meters are reading? Can he explain what takes place in a receiver from the aerial post to the loud speaker, and explain the function of each part? Does he know anything about wavelength, radio frequency, kilocycles, neutralizing and balancing? I believe not.

Then why should a radio Service Man be a licensed electrician?

Mr. Saunders also mentions the correspondence schools and the three to six month courses, turning out men who expect big pay. I really believe the schools are doing a lot of good. One of our leading men in radio is at the head of one of these schools—Lieut. Schnell, a licensed amateur for many years, who showed the U. S. Navy what could be done with short waves.

It was an amateur who gave us regeneration—a feature used in practically every broadcast station.

In conclusion, I want to say that I am a firm believer in the home set builder and the experimenter; radio today owes a lot to them.

I am a licensed amateur, having built all my own transmitting apparatus and short-wave receivers; and I have a good reputation as a Service Man and a very good business in the radio service line.

IRVING S. BOYTON, W1ADJ,  
Noroton Heights, Conn.

### DO ARRESTORS ARREST?

Editor, RADIO-CRAFT:

I read Mr. Saunders' letter, and can't say I agree with him. I have seen some of the jobs which some of the electrical men have turned out in the last few years. It was in the beginning of radio broadcasting that every electrical man, telephone man and garage mechanic was an expert, just because he fooled with something electrical. I have talked to a lot of these birds, and they are O.K. in their line; but get them into high frequency, inductive relations, shielding and a dozen other things, and they don't know where they're at.

As for service sheets, we don't need 'em; but they speed up the work if you have them, without tracing everything out.

Another thing that burns me up is the bunk about lightning. I wouldn't give a hoot for all the lightning arrestors in the United States, even if they do carry the underwriters' O. K. I have fixed a dozen sets in the last week which picked up high induced charges in the antenna. Did the arrestor protect the set? I guess not. There is nothing that will beat a S.P.D.T. knife switch in the antenna when it comes to lightning protection. So, why blame the Service Man for improper installation when the underwriters say arrestors are O. K.?

I think the boys with plenty of practical experience and a small amount of technical knowledge can, in most cases, beat the man

(Continued on page 231)

# Servicing Automotive Radio

*A review of the special problems which the Service Man will meet, written from considerable experience in this work*

By J. KENNETH WINDLEY

**I**N this article the writer has necessarily made numerous references to the Transitone radio set (described in the February and March issues of RADIO-CRAFT) because of his connections with an organization specializing in the installation and service of this make. To the uninitiated it may be pointed out that the data that follow are applicable, in their fundamental information, to practically all automotive radio jobs.

Reviewing the car radio installation we find that it usually includes several stages of tuned R.F. amplification, detector and the customary audio amplifier unit. A five-foot length of copper screen, tacked under the head lining of the top, serves as the aerial; and the metal body of the car acts as the counterpoise, or ground. In convertible cars, fifty to one hundred feet of fixture wire is often used in place of the screen.

It will be found that the tuning of Transitone sets, for example, will vary slightly with a change of aerial, depending upon its length and the capacity between it and the metal of the car body. This capacity varies in different cars, according to the way the aerial is placed in the top, and it is therefore impossible to subject the set to an accurate bench test before being installed in the car.

Each R.F. transformer in the tuning unit is provided with a "trimmer," making it possible to tune all stages to the same frequency. By far the greater part of the troubles in these sets, including the lack of distance, volume and selectivity, as well as microphonic howls and poor tone quality result from faulty alignment of these units.

## A Useful Oscillator

Briefly, this tuning operation may be done in any one of three ways: First, by ear, which is so inaccurate that it should not be attempted; second, by placing a low-reading milliammeter in the plate lead of the detector tube (this method is more accurate but exceedingly slow. However, we will outline it briefly further along in this article); third, and best, is the use of a suitable oscillator.

By using the instrument described here, it is possible to align the R.F. units to within a margin of less than five hundred cycles; which is of course, much more accurate than will be found necessary. Since this instrument was built, there has been no difficulty in clearing up even the most obstinate cases coming into our shop; and it has saved our service department any amount of money by cutting down the time required for service, and eliminating our returns.

It comprises a regenerative detector and a local oscillator, the tuned grid circuit of which is the tuned circuit of the R.F. stage to be tested (see Fig. 1). No batteries are contained in the instrument, since the filament and plate supplies are obtained directly from the radio receiver. No rheo-

stats nor meters are used on the tester; and a pair of headphones or speaker is used to indicate resonance. A plug made from an old UX tube base, connected to a four-wire cable, serves to couple the instrument to the radio receiver. The whole unit is fitted into a metal can which shields the coils of the two oscillating circuits from each other.

While this instrument as described will work equally well on any battery set using '01A's in the R.F. amplifier, it is adaptable to screen-grid auto receivers if the proper changes are made in the plug, and '27-type

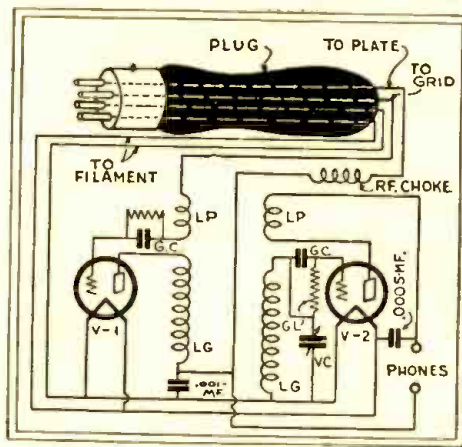

Fig. 1

*This compact unit was designed especially for automotive work and is a time-saver. It will be seen that, when the plug is inserted in an R.F. tube socket, the tuned circuit of that stage becomes the grid circuit of the oscillator V-1.*

tubes are substituted for the '01A's in the oscillator itself. The cathode terminal of the '27 socket in the tester must in that case be connected to one side of the filament, to provide the grid return. The values of the parts in the oscillator will remain essentially the same.

If grid resistors are used to prevent oscillation in a battery set, it may be necessary to short them out to make that circuit oscillate while aligning the tuning condenser. This shunt will not change the resonant frequency of the circuit.

## Control of Oscillation

The detector circuit of the tester should tune over the entire broadcast spectrum. In the experimental model shown, "5-and-10" basket-weave inductances were used, but any type of coil will prove satisfactory. The following values are recommended: Lg, 120 turns of No. 28 D.C.C. wire, wound on a 1½-inch tube; Lp, 25 turns of No. 28 D.C.C., wound in the same direction on the same form and spaced ¼-inch from Lg. The plate and grid leads are at the extreme ends of the coil.

While no oscillation control is included in the tester, both circuits should oscillate smoothly over the entire dial. The detector circuit should neither howl at the highest frequency nor pop out of oscillation at the lower. A howling condition may be remedied by either removing a few turns from

the tickler or using a smaller capacity between the plate return lead and the filament. Oscillation may be determined by tapping the grid with the finger and listening for a click in the phones.

Oscillation in V1 may be determined similarly by connecting the phones in series with the R.F. choke on the cable side. Due to the capacity between the grid lead and the other wires in the plug cable, V1 will oscillate at a frequency lower than that of the other tuned circuits in the unit. This does not defeat our purpose; because the decrease is equal on each stage, and makes it possible to use the second harmonic of this circuit for our heterodyne note in the phones. The result is sharper tuning.

When the finished oscillator is plugged into a tube socket and the dial rotated, a squeal will be heard at one setting. One must slightly change the setting of the receiver dial, to be sure that this is produced by the receiver itself and not by a local broadcast station. Now tune the oscillator for a "no sound" position (zero beat) and, if the receiver is adjusted properly, the zero beat will be found in exactly the same place in all the sockets.

## Balancing the Receiver

To peak the R.F. unit, first unscrew all the trimmers as far as they will go, then simply locate the socket in which the dial reading at zero beat is lowest, and screw the trimmers on the other coils in until they match with each other. It is extremely important that the trimmers be as far out as possible, yet keep the R.F. units balanced. This is because of the absorption effect of the copper discs of the trimmers when screwed too far into the radio-frequency coils. If the stage does not align itself before the plunger is screwed in three-quarters of the way, the outside stator plates of the tuning condenser opposite this coil should be bent out slightly to compensate for this. It will be found that the frequency of the stage will increase as the plunger is screwed inward (the "Peridyne" effect—Editor).

Perhaps the simplest method of neutralizing is to tune in a strong local signal of about 1100 kilocycles, place a burnt-out '01A tube in the first R.F. amplifier socket and, with an insulated screwdriver, adjust the first neutralizing condenser until the signal becomes weakest. This procedure is then followed on the two remaining stages.

The plate voltage of the R.F. amplifier tubes (yellow cable lead) should be as high as possible (112½ to 135 volts) without causing them to oscillate. This will give considerably more pep to distant signals. Otherwise, microphonic howl is liable to result.

## Use of a Milliammeter

Those who do not have enough Transitone repair work, to justify building the oscillator described here, will find a low-reading milliammeter a great assistance in tuning

(Continued on page 232)

# Modernizing the Freshman "Masterpiece"

*A quick and simple method of adapting a popular battery model receiver to all-electric operation. Such work offers opportunities to the Service Man to get orders from set owners, or recondition turned-in sets.*

By EDWARD C. HUBERT

**D**O you remember when the first Freshman Masterpiece appeared on the market? It sold for about sixty dollars, a low price for a five-tube receiver in those days, and immediately became a "best seller" all over the country. Many are still in use; but most owners have long since traded in their "Masterpieces" for more modern, electric sets. The ironical side of the trade-ins is that the new "modern radios" use practically the same circuit as that in the old Masterpiece. The screen-grid receivers, of course, exhibit several variations from the old sets and can be called new. But the average electric radio in present use employs the old stand-by—straight tuned radio-frequency with two stages of audio.

Therefore, as the fundamental circuit of the new and the old sets is the same, it should be easy to modernize the old "Masterpiece." It is easy.

## Removing Unnecessary Parts

Without further ado, let's go to work on it. First remove the three screws which hold the chassis in the cabinet. Slide out the chassis; then turn the chassis upside down, so that the sub-panel faces the ceiling. Carefully trace all filament wires, from the switch in center of the front panel to the tube sockets, rheostats and binding posts marked "A—" and "A+". Then clip one wire at a time; as the wiring may confuse you if several leads are cut out at once.

After all the filament leads are cut out, remove the filament switch and rheostats from the panel. In the holes formerly filled by the rheostats, put variable resistors. I

used Resistograds, but any 2000- or 3000-ohm variable resistors will do; these, marked in the diagram as R1 and R3, serve to provide "C" bias for all tubes.

A small hard-rubber knob can be placed in the hole formerly filled by the filament switch, and screwed in, to fill up the space and give the panel a harmonious appearance. While we have clear space to work, it would be best to put in the 1-mf. by-pass condensers; C5 is connected across the bias resistor R1, and C6 across R3. Each condenser is mounted beside its corresponding resistor, so that the leads will be only an inch or so long.

Now remove the detector socket; for it will be necessary to substitute a five-prong UY socket to receive the '27 detector tube. The "Masterpiece" I remodeled had brass sockets, held to the sub-panel by brass eyelets. Prying them out was impossible; so, finally, I removed them all by drilling. Use the smallest drill that will catch hold and do the trick; removal is then easy. Only the detector socket need be removed. Push a sub-panel type UY socket through the hole formerly filled by the brass shell. Some sub-panel sockets can be mounted right over the hole, the prongs extending through. If the new socket is placed carefully, it may not be necessary to drill any more holes.

## The New Wiring

Now solder two flexible leads (lamp cord is good) to the filament prongs of the UY socket. Make them two or three feet long, because the filament current comes from an external transformer. Be sure that all filament leads are twisted together.

Now take another piece of lamp cord about four feet long and, keeping the wires twisted, solder this piece to the filament strips of the first audio amplifier tube. Let it cool, and extend this wire along to the filament strips of the first and second radio-frequency tubes. This will connect the filaments of the first R.F. the second R.F. and the first A.F. tubes in parallel, and carry current for the three '26 amplifier tubes. While at work soldering these filament leads, put in the 20-ohm center-tapped resistor R5. With stiff bus bar, about one inch long, fasten the center-tap resistor across the filament leads, just under the second R.F. tube socket. This will bring R5 close to the bias resistor R1 and the by-pass condenser C5, and make short, simple wiring. Complete the wiring to R1; then turn the set upright, as it would be in the cabinet, and connect together the rotors of all three variable condensers. This is done by running two short pieces of insulated wire, one from each of the angle brackets, which hold the center condenser to the sub-panel, to the angle brackets which hold down the two end condensers. Then a lead is run along the upper side of the sub-panel, from the angle bracket on the middle condenser to the "B—" binding post, which is found near the center at the rear of the sub-panel.

## The Power Stage

As no set today is "modern" without a real power tube, we will have to solder separate filament leads to the last audio socket. When this is done, we have three separate filament outlets: the leads to the detector for 2½ volts; the leads to the R.F.

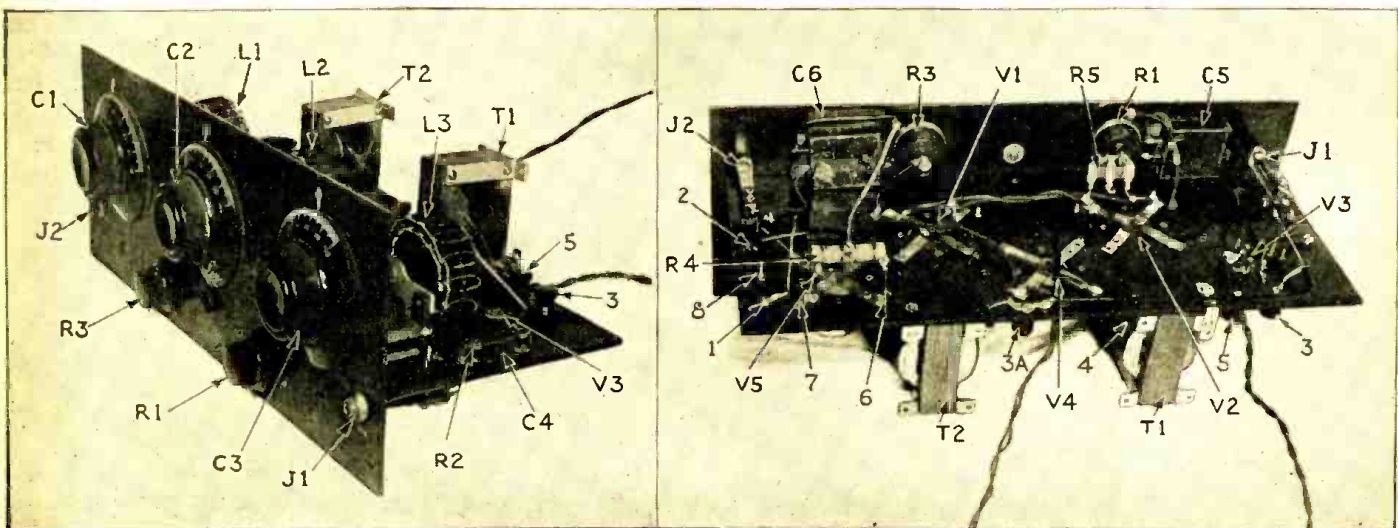

Fig. A

Fig. B

At the left, a Freshman "Masterpiece" chassis, after the alterations described in this article; the front appearance remains similar. At the right, a view of the new wiring. The parts may be identified by reference to Fig. 2. The location of the power switch is optional; it may, of course, be mounted in place of the filament switch on the panel.

tubes and the first audio, for 1½ volts; and the leads for the power stage, for 5 volts for a '71A tube. If a '45 power tube is to be substituted for the '71A, it will be advisable to use a separate 2½ volt winding on the transformer; don't use the same winding that supplies the detector. A '71A in the last stage will be found very satisfactory, when lighted from a 5-volt winding on the transformer.

While soldering the filament leads for V5, put in the 20-ohm center-tapped resistor R4 across the leads. The mid-tap is run over to the resistor R3 which biases this stage.

Nothing has been said so far about plate

posts on the audio transformers also run to their respective bias resistors; that on T1 goes to R1, as shown in the diagram, and that on T2 is connected to R3. The leads are made short by using the screws which hold the condenser brackets; since the brackets connect to "B-". Make all leads as short and direct as possible.

**Operating Adjustments**

If the set oscillates badly, first adjust your biasing resistors. This can be done by ear fairly well; but the best method is that of inserting a milliammeter in your "B+ Amp." lead and noting the flicker during a

slightly, and control volume that way. However, if the selectivity is good, a variable resistor can be inserted between the aerial lead-in and the set, to control the volume.

Any standard "B" power unit which will supply current and voltage to a five-tube receiver, allowing for the '71A or '45 power tube, may be used.

The total expense of electrifying the old Freshman "Masterpiece" should not be more than ten dollars; except for the "B" unit, which most radio fans already own.

**List of Parts**

- Two Pilot "Resistograds" (R1 and R3);
- Two Aerovox Center-tap 20-ohm resistors (R4 and R5);
- Three Dubilier 1-mf. by-pass condensers (C5, C6, C7);
- One Na-Ald sub-panel UY tube socket, for V3;
- Two good quality, low-ratio, replacement audio transformers (T1 and T2);
- Three '26 tubes (V1, V2 and V4);
- One '27 tube (V3);
- One '71A or '45 tube (V5);
- One 25-foot coil of insulated hookup wire;
- One 25-foot coil of lamp cord, or other large stranded wire, for filament leads;
- One filament transformer, external, to feed three '26 tubes, one '27 and one '71A or one '45;
- Four small angle brackets, to hold down T1 and T2;
- Six lengths of black spaghetti;
- One assortment of Daven grid leaks, 2 to 5 megs (R2).

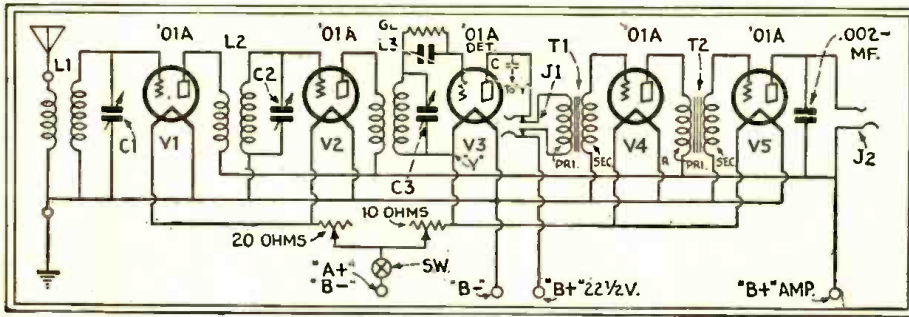

Fig. 1

The original circuit of the "Masterpiece" receiver described in this article, before the work of alteration began.

leads or audio transformers. And the speaker jacks; what about them? Well, I thought it advisable to do away with the jack J1 (labeled "Phones"); so I clipped off the wires connecting to this jack. For the sake of appearance I left the jack on the panel, although it is "dead." The other jack J2 (labeled "Speaker") I left connected but clipped the wire which ran to the "B+ Amp." binding post, a little short, and ran it to a separate binding post, "B+ Power." All other plate leads, with the exception of the detector, are common and get about ninety volts. These leads won't have to be changed very much. Run the busbar that connects them to the "B+ Amp." binding post (3A) to avoid later confusion.

**Transformer Replacements**

It is possible to use the old, diminutive audio transformers in this "Masterpiece"; but the tone quality will not be good, the primaries are liable to burn out under the higher voltage, and your labor will appear a waste of time. So I strongly advise taking out one audio transformer at a time, and substituting modern, heavy-built components. I, personally, picked up two good ones in New York City for forty-nine cents apiece; so the item of expense is small and well worth while. As there was little room for them under the sub-panel, I mounted them on top of the sub-panel; T1 between the first A.F. and the detector sockets, and T2 between the two A.F. sockets. The layout is shown in the photograph reproduced here. The "B+" post of the first audio transformer is run to the "Detector" terminal, and should be supplied with about forty-five volts. The "C-" post of this transformer goes to the "B-" terminal. The second audio transformer gets about ninety volts from the common "B+ Amp." lead, or terminal. The "C-" post on this audio transformer also goes to "B-". Both "C-

strong signal. Adjust R1 until you get the least flicker of the needle. Then put the meter in series with the "B+ Power" lead, and adjust R3 until you get the steadiest reading. Distortion can be eliminated in this way.

Try various values of grid leaks, between 2 and 5 megs. The grid condenser C4 should be of about .0001-mf. capacity. Vary the detector voltage in your "B" supply unit. If oscillation persists, insert grid suppressing resistors—about eight hundred ohms value—in the grid circuits of V1 and V2 at X. If the set should motorboat, you can cure it by adding another 6- to 10-mf. high-voltage condenser (C8) across your "B+ Power" post and "B-". Ground your "B-" through a 1- or 2-mf. condenser C7; never run a direct connection to the ground. Keep your filament leads away from all other wires as much as possible.

No volume control has been mentioned; since it is easy to detune a three-dial set

**What is a Reliable Tube Test?**

A CHALLENGE to the designers of a testing apparatus is contained in a recent bulletin issued to its service representatives by the Philadelphia Storage Battery Co., which manufactures not only receivers, but tubes, under the trade mark of "Philco." It says:

"We have done a lot of work with all kinds of tube testers, in an effort to find one that would be practical for our distributors to use. We have not been able to find any tester that could be used by a distributor and which would give accurate

(Continued on page 233)

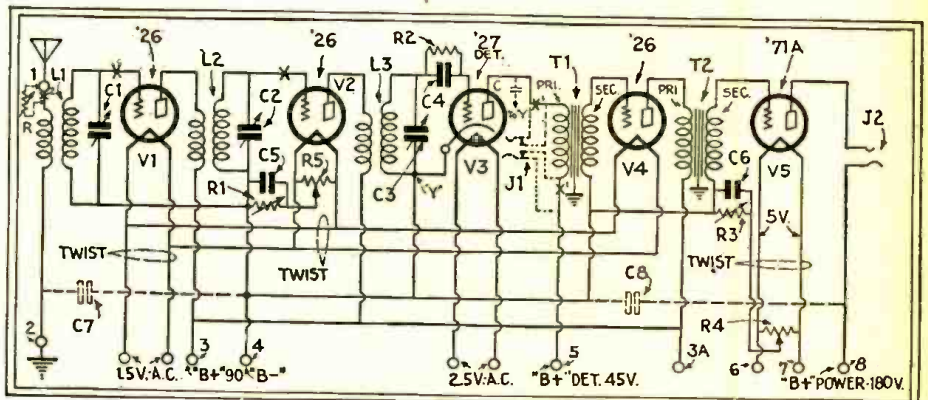

Fig. 2

The rebuilt "Masterpiece," electrically operated from a transformer and "B" power unit of standard type. The connections shown in dotted lines are optional, as explained in the text. Some set owners may prefer to retain jack J1 for use with phones. The additional by-passing and resistors may prove desirable; R may be 500,000 ohms.

KOLSTER K20, K22, K25, K27 AND K37 SIX-TUBE RECEIVERS

Before proceeding with a detailed description of these Kolster receivers, of which the "K20" is the most popular representative, we will point out the major differences that differentiate the several models broadly referred to as the "six-tube" sets. The "K20" model is a table-type radio receiver incorporating the four-tube chassis and the two-tube audio amplifier, which is combined with the 60 cycle power-supply unit shown in the schematic circuit; the "K25" has the same general design for operation on 25 cycles. The "K22" is a console arrangement of the tuner chassis and power pack used in the K20; while the "K27" is a console adaptation of the 25-cycle equipment. Another model of the Kolster line was designed for use as a portable demonstrator; this number, the K37, employs the circuit of the K20.

The service department of the Kolster Radio Corp. points out that the use of a lamp for testing continuity in the Kolster sets will probably cause the grid resistors R1, R2 or R3 to burn out; a high-resistance meter and low voltage should be used, instead.

The unit at the left end of the panel, constituting the "sensitivity" control, comprises a tap-switch controlling the inductance value in the antenna coil that is being used; and also tunes the combined variometer and variocoupler L1.

It is pointed out that the low-frequency response characteristic of the A.F. transformers used in these sets is particularly good and this should be considered when there is a complain of exceptional hum; for the least bit of disturbance of the circuits may develop an A.C. hum that would not be evident in many other makes.

Volume control is centered in R5.

Following are the values of the parts used in all the models mentioned above: Resistors R1, R2, R3, 1700 ohms; R4, 2 or 5 meg.; R5, 25,000 ohms; R6, R7, 6 ohms. These values are found in the vitreous voltage-divider: R8, 840 ohms; R9, 60 ohms; R10, 220 ohms; R11, 3,000 ohms; R12, 3,000 ohms.

Condensers C5, C6, C7 are 45-mmf. capacity; C8 is .00025-mf.; C9, .002-mf.; C10, C11, 0.6-mf.; C12, 1.0-mf., 400 V.; C13, 2 mf., 160 V.; C14, 2 mf., 400 V.; C15, 2 mf., 400 V.; C16, 1.0 mf., 400 V. The condenser bank in the power pack contains units that may be identified by the following color code for the leads: C12, blue, and yellow; C13, black, and green; C14, gray, and brown; C15, red, and brown;

C16, orange, and black with white tracer. The values given are for 60-cycle operation; for 25-cycle operation the following changes are to be noted: condenser C16 has a capacity of 4 mf., and returns to the tap between R8 and R9, instead of the tap between R9 and R10 (chassis ground).

Choke Ch1 has a resistance of 3,000 ohms; Ch2, 1,300 ohms; Ch3, 800 ohms.

Jack J is the provision for phonograph pick-up connection.

Pilot light V8 is of the 2.5-volt type and operates at 2.2 volts.

Hum control resistor R6 is located at the top right front corner of the tuner chassis; while hum control R7 is placed at the rear.

The tube sockets, mounted along the back of the receiver chassis, are in numerical order; with V1 at the left and V4 at the right, behind the grid leak.

Following are the average normal voltages at the terminals on the connection panel: 1-2 (R.F. filament) 1.5 V., A.C.; 3-6 (heater bias) -3 V., D.C.; 3-5 (detector plate) +45 V., D.C.; 3-7 (grid bias) -6V., D.C.; 4-7 (R.F. plate) +90 V., D.C.; 8-9 (detector heater) 2.2 V., A.C. The power-transformer output is 300 volts A.C. on each side of the center tap.

Accidental grounds of instruments to chassis may be due to defective fiber washers.

Circuit oscillation may occur in any receiver; the possible sources of the trouble will vary with the individual design of each receiver. In the case of Kolster sets incorporating the circuit shown, this fault may usually be localized to one of the following causes: poor tubes; shorted R1, R2 or R3; excessive voltage at tap 4 on the connector plate; C10 or C11 open or shorted; antenna too long; poor ground conditions; reversed primary winding of the special R.F. transformer combination L1; shorted C5, C6, C7, C8 or C9; or open C9.

Microphonic howl will yield to service attention directed with regard for the same factors as mentioned above in connection with circuit oscillation. Substitution of a 5-meg. resistor, for the more usual value of 2 meg., in the grid-leak R4, is sometimes a successful curative measure. Additional palliatives may be necessary; such as changing the positions of the exposed corner plates of C5, C6 and C7, and noting the result upon retuning; or bending the bus-bar leads to the circuit balancing condenser at the right of the variable condenser grid (and therefore on the side toward the connector plate—as we call the power pack-

chassis connection posts) so that it is further removed from the shield of this 4-gang component. (This variable condenser, in shunt with C4, is not shown in the schematic circuit.) Increasing the value of R1, R2 and R3, up to 2,100 ohms each, also may reduce the sensitivity to a satisfactory value. If the resistors in the grid leads of V1, V2 and V3 are uniformly changed in value the balance in these circuits will not be disturbed. Another resort may be to remove entirely one of the grid condensers, preferably C6, (leaving the shunting resistor in circuit). A thorough inspection should be made for looseness in the cabinet, and to determine whether the chassis is properly mounted so that it floats on the rubber cushions.

To remove this chassis, first take out the power pack; then unscrew the cap screws in the bottom of the set. Next, remove the three knobs on the control shafts (the antenna switch lever is to be removed by unscrewing a screw and lock-nut; there is also an escutcheon nut to be removed from the control switch, and another nut which fastens the volume-control shaft to the panel).

To replace a drive cord there will be needed a pair of long-nose pliers, a screw-driver, and a No. 7 Spintite wrench. The replacement cord should measure 13 inches, from knot to knot, after being thoroughly stretched. Now, turn chassis upside down and put both ends of cord through the opening in the chassis, so that the cord will loop around the main drive pulley. Next, turn the chassis to obverse side and rotate the tuning drum; so that, holding the drum tightly, one end of the cord can be threaded over the rear idler pulley, underneath the drum, and the cord brought up until the knot can be placed in the socket (at about 12 on the dial). The other end is to be looped over the other idler pulley and under the dial drum to the front of the set; it may then be grasped with the pliers, and the knot caught into the slot in the tension spring provided.

The line-current consumption of these models is 50 watts; and the following resistance values may be used for resistors in series with the line where it is deemed necessary to reduce the line voltage (the first figure is the potential of the line above the desired 110 volts, and the second is the value of the series limiting resistor): 112.7 V., 7.0 ohms; 114.0 V., 10 ohms; 115.1 V., 2.5 ohms; 116.1 V., 15 ohms; 119.0 V., 22 ohms; 122.7 V., 31 ohms; 128.7 V., 45 ohms; 136 V., 62 ohms.

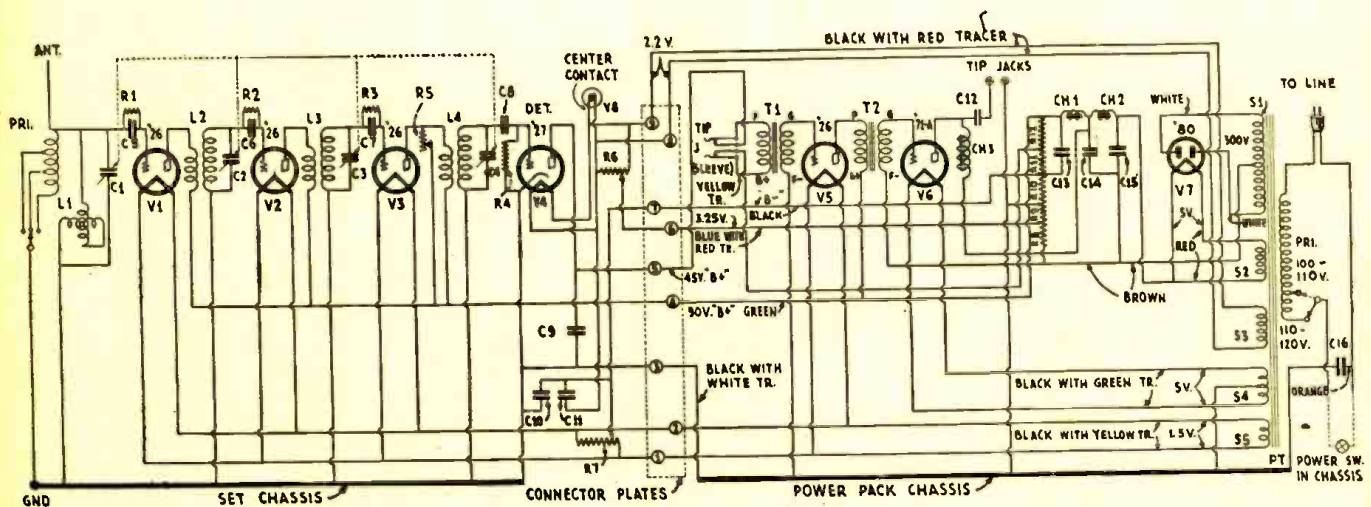

Above, the circuit used in the group of Kolster models listed at the top of the page. The details and connections of the R.F. chassis (left) and the audio amplifier and power pack (right) are those of the 60-cycle models.



COLUMBIA SCREEN-GRID 8 RECEIVER

This is a standard receiver under a number of names in Chicago, Ill. Its manufacturer is: capacities C4, C5, C6, C7, C8, 0.88-mf.; C12, C13, C14, C15, C16, C17, C18, C19, C20, C21, C22, C23, C24, C25, C26, C27, C28, C29, C30, C31, C32, C33, C34, C35, C36, C37, C38, C39, C40, C41, C42, C43, C44, C45, C46, C47, C48, C49, C50, C51, C52, C53, C54, C55, C56, C57, C58, C59, C60, C61, C62, C63, C64, C65, C66, C67, C68, C69, C70, C71, C72, C73, C74, C75, C76, C77, C78, C79, C80, C81, C82, C83, C84, C85, C86, C87, C88, C89, C90, C91, C92, C93, C94, C95, C96, C97, C98, C99, C100.

may be either  
 lab 30,000-ohm  
 R3, R4, R12,  
 100 ohms; R6,  
 R10, 30,000  
 30 ohms.  
 R3 consist of  
 wire; Ch4,  
 covered wire.  
 adjacent to  
 1250 ohms;  
 pack), 400  
 er's field wind-

of, underneath the  
 following resistor units,  
 this order, starting from  
 strip on which are mounted  
 impedances and capacities:  
 R10, R7, R6, R11, R12. Re-  
 connected at the side of the re-  
 ne lug being soldered to R9 and the  
 Resistor R2 is mounted at about  
 of the strip carrying the R.F. coup-  
 impedances and capacities. Resistors R13  
 R14 are located at the power pack.

Between the tuning drum and the power trans-  
 former is located a condenser bank, which com-  
 prises the following capacities: C11, brown-  
 white leads, 300-volt rating; C15, slate, and  
 green-white, 200 v.; C16, red, 300 v.; C17,  
 green, and green-white, 600 v.; C18, red, and  
 green-white, 600 v. The '80 tube fits in the  
 corner, behind the power transformer; the other  
 tubes range along the back of the chassis in  
 numerical order.

It will be observed that the metal brackets  
 (shown dotted in the schematic circuit) sup-  
 porting the R.F. chokes Ch1, Ch2 and Ch3, are  
 connected to the cathodes of the screen-grid  
 tubes; approximately three thousand receivers

were manufactured with these brackets connected  
 to low-potential end of the tuned secondary  
 inductances; while seventeen thousand more were  
 made with these supports grounded to the chas-  
 sis. The final circuit, shown in this Data  
 Sheet, was responsible for greatly improved sta-  
 bilization of the R.F. circuits, at the upper end  
 of the tuning dial.

If oscillation exists, only between 95 and 100  
 on the tuning scale, changing the R.F. chokes  
 above mentioned for units having 650 or 675  
 turns will probably eliminate this tendency,  
 which may exist in a few instances. The reason  
 for this circuit oscillation is that the chokes are  
 designed to resonate at a wavelength just above  
 the upper end of the broadcast band; this re-  
 sults in obtaining more even amplification  
 throughout the tuning band.

Circuit oscillation, between 70 and 100, may  
 be caused by an open or short in C8.

The makers of this receiver, in their manual,  
 stress the point that the Service Man should  
 determine whether the radio receiver has a  
 good ground connection and a set of good tubes,  
 before looking further for faults in operation.

Circuit oscillation or strong regeneration may,  
 in some cases, be traced to lack of the shield  
 which is furnished as a cover for the bottom  
 of the chassis.

Power detection is used in this receiver:  
 Note that the detector is resistance-capacity  
 coupled to the first stage of A.F. amplification.

Hum will result if one of the '45's loses  
 emission, thus disturbing the balance in the  
 push-pull circuit. This same defect will prob-  
 ably cause circuit oscillation in the R.F. stages,  
 due to the rise in voltages when the load of  
 one of the power tubes is lessened.

Where high signal gain is obtained in the  
 R.F. amplifier, it is in most cases necessary  
 to have two volume controls; one to vary the  
 amount of signal input to the first tube, and  
 another to vary the amount of amplification ob-  
 tainable through the R.F. amplifier. Here these  
 functions are combined in R1 by employing the  
 circuit shown and the values given above.

Coupling condensers C4, C5, C6, are made  
 in a novel manner. Exact spacing between the  
 two plates is obtained by using a celluloid  
 washer having a thickness of .025-in. Capacity  
 adjustment is obtained, not by varying a screw,  
 but by changing the spacing washer of each  
 condenser; and tightening the holding screw to  
 the fixed point that is necessary to hold the

plates tightly in position. The selectivity of  
 this receiver may be increased, at the expense  
 of selectivity, in special installations by sub-  
 stituting, for the .025-in. washer furnished in  
 the chassis, celluloid spacers having a thickness  
 of .020- or 0.030-in. It is important to remem-  
 ber that any increase or decrease in the ca-  
 pacity of these condensers does not unbalance  
 the tuning circuits, so long as the increase or  
 decrease in the amount of capacity is alike  
 in all stages.

A defect in the "radio-phonograph" switch-  
 ing system such as the switch's failing to connect C10  
 or to open the pick-up circuit, may cause a  
 loud hum.

Following is a table of average operating  
 voltages for this receiver, taken at a line po-  
 tential of 115 volts, with the volume control  
 set at maximum, and the power transformer's  
 primary-tap switch set at the position shown  
 in solid lines in the schematic circuit:

		Tube in Tester			Ma. Ma.	
					Nor-Grid	
Tube	Out	"A"	"B"	"C"	K	mal-Test
V1	2.45 180	2.40	174	— 1.5	1.5	4.5 6.7
V2	2.45 180	2.40	174	— 1.5	1.5	4.5 6.7
V3	2.45 180	2.40	174	— 1.5	1.5	4.5 6.7
V4	2.45 106	2.40	106	— 14.5	14.5	0.2
V5	2.45 162	2.40	68	— 3.0	3.0	3.2 3.8
V6	2.35 230	2.20	212	— 38.0	—	20. 23.
V7	2.35 230	2.20	212	— 38.0	—	—

The screen-grids should carry 80 volts posi-  
 tive potential.

Condensers C7 and C9 are contained in one  
 case. The identifying colors are: C7 lead, red;  
 C7-C9 common lead, four cabled red leads; C9,  
 blue.

Condensers C10 and C19 are contained in one  
 case. The identifying colors are: C10 lead,  
 green; C10-C19 common lead grounded; C19,  
 slate.

The color code for the detector tone filter con-  
 densers and coupling condenser, contained in  
 one case, are: C12, green; C12-C13 common  
 lead, yellow; C13-C14 common lead, red; C14,  
 brown.

To prevent circuit oscillation, the tube shields  
 must be fastened securely.

A defective rubber grommet on the pilot-light  
 assembly will short one side of the '45 filament  
 winding and cause R13 to burn out; resulting  
 in hum, no signal, or a burnt-out or shorted  
 power pack.

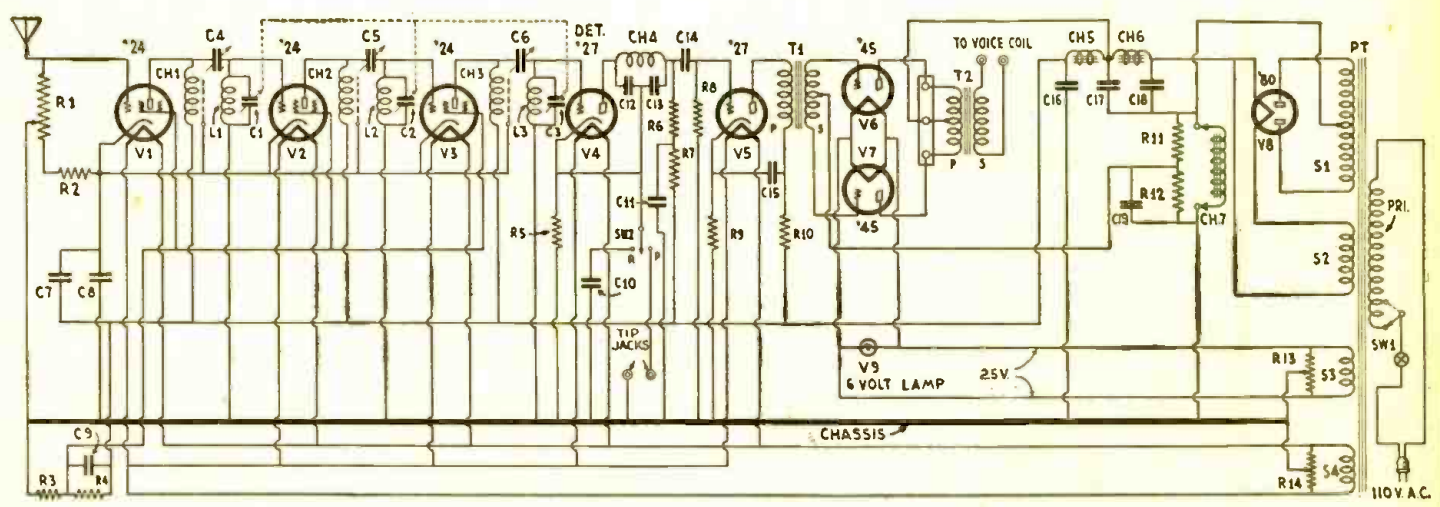

This seven-tube modern receiver is manufactured for distribution by retailers, jobbers and mail order houses under their private brands. Observe the metal brackets indicated by dotted lines alongside Ch 1, Ch 2 and Ch 3; the connections of these vary in different receivers, as explained in the text.

# The Junior Service Man

*There is no denying that, the better his tools and instruments, more easily and quickly a radio man can work. Many are no fortunate as to have set analyzers, however; and this article shows what can be done without them, in a pinch.*

By L. H. HOUCK

October, 1930

**M**ANY practical radio tests may be made by Service Men without using expensive test equipment. Of course, competent Service Men carry first-class equipment for elaborate tests; but oftentimes the trouble has been located before using the test equipment. Then, too, the average experimenter does not desire to invest a comparatively large sum of money in test equipment, just for his own use.

It is not intended that the reader shall gather from this article that accurate, high-class test equipment is not desirable; but many tests can be made, with a great measure of accuracy, without it. Of course, it is impossible to read the value of a tube without some sort of a tube tester. But a bad tube can be eliminated from a radio set by the process of elimination; through using a tube known to be good in each socket of the set.

For instance, we have a home-built battery or eliminator set of the tuned-radio-frequency or regenerative type, which is not operating. The speaker is dead. On touching your finger to one side of the grid leak of the detector tube, there will be a continuous roar in the speaker—if the audio channel is O. K. This simple test shows that the detector tube and the two audio tubes are all right. It also indicates that the two audio transformers are not burned out. It gives a test of the speaker, for if the speaker windings were open there would be no sound. So it is seen that this one simple test

will give a rough idea of the condition of about half the apparatus in the set. Then it also gives a chance to change tubes. If the roar is loud and clear in the speaker then the audio tubes are in good condition. Place a doubtful tube in the audio side and try it again—if there is no sound, or it is very much weaker, the tube should be discarded.

### Testing the First Stages

If we have disposed of the detector and audio stages, and still there is no reception (taking for granted, of course, that there is broadcasting on the air) attention can be given to the radio-frequency side of the circuit. If local stations are known to be in operation, remove the aerial lead-in from the set's "antenna" post, and carry the end of the wire into the set to the stator (which is the part of the tuning condenser that does not turn) of the first variable condenser, whether single or ganged. Set the dials for a local station and listen for signals. If the

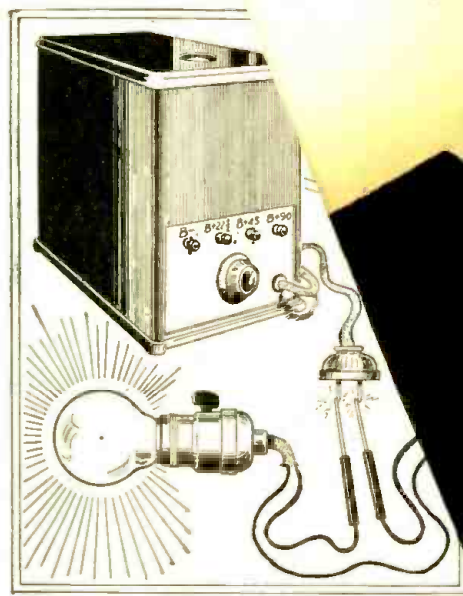

Fig. 2

The electric lamp and house current form a tester which should be known to every Service Man; when the lamp lights, there is a short or a low resistance across the leads. Again—first know what you are doing, when you apply the test.

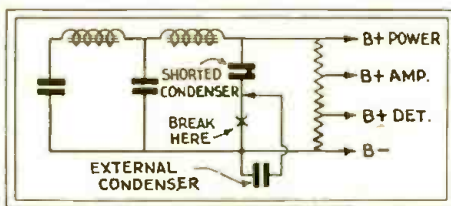

Fig. 3

A shorted unit in a condenser bank need not make a total loss of the whole unit. Put the replacement on the outside.

set is still dead, move the lead-in wire to the second and to the third. In a large majority of the cases the broadcasting will come through on the stator of at least one of the condensers.

If on placing the lead-in wire on the first condenser, signals are received, yet none are received when the lead-in is placed on the antenna post, an open circuit is indicated between the antenna post and the first coil (the antenna coupler) which is of similar design in most sets to the other two radio-frequency coils) or in the primary winding of this coil. The experimenter has learned, at least, that the set from that point clear to the speaker is in operating condition. The trouble is thereby isolated to a very small section of the set.

Suppose, then, the experimenter has no meters, and even no headphones, to make a continuity test of this part of the set; a loud speaker may be used. Place one of the speaker tips, after disconnecting both from the radio set, on a battery (or eliminator) lead, and then take a wire from the other side of the circuit. When the other tip of the speaker and this wire are touched together, there will be a sharp click in the speaker. If an eliminator is used, it is

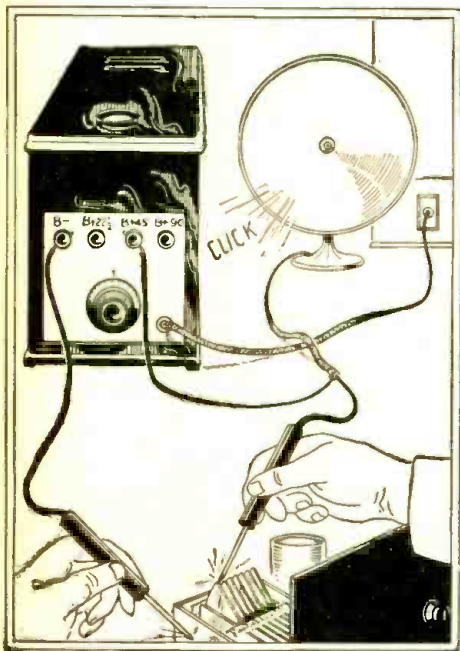

Fig. 1

The "B" power unit, in connection with a speaker, forms a continuity tester. If the unit is in the receiver chassis, the leads from it may still be used—if the tester knows the circuit he is working with.

advisable to keep the set turned on and the power output hooked to the set; as using this unit without a load imposes a heavy strain on the condenser bank and might cause a burn-out.

It is readily apparent that any conductive material placed between the two test leads will cause a click in the speaker; indicating the continuity of the object being tested. Place one tip on the antenna post and the other on the ground; a click will indicate that the primary winding of the antenna coil is intact. Placing the tips on the rotor and stator plates of the variable condensers should give a loud click. If this surprises the reader who knows that the plates are surely separated by air, a glance at the diagram of your set will show that these condensers are placed across the secondaries of the radio-frequency transformers and of the antenna coil; so that in reality you have just made a test of the secondaries of these coils. With a diagram of the circuit of the set, it should not be hard to figure out just when you should get clicks with this continuity tester and when you should not.

A "B" power unit can be tested properly only with a high-resistance voltmeter (about a thousand ohms per volt.) But the experimenter can get an indication whether there is any current flowing, by momentarily placing the speaker tip on "B—" and applying the other tip alternately to detector, intermediate and power amplifier taps. If current is flowing the fact will be shown by a click. If the power unit is of the type using a Raytheon ionized-gas rectifier ("BH")

(Continued on page 235)

# Operating Notes for Service Men

*Mr. Freed follows the excellent idea of keeping a notebook and jotting down his experiences with sets of this and that model. Consequently, he has a "line" on many of them which saves time and worries.*

By BERTRAM M. FREED

**M**ANY Service Men are confronted by the task of eliminating hum from a Philco "Model 87" ("Neutrodyne Plus"); this may be either almost tolerable or quite objectionable. Changing tubes, adjustment of the hum-balancer, reneutralizing, and reversal of the A.C. line plug result in little or no improvement; though some benefit may be obtained from cleaning all points of contact, such as the prongs of the tube sockets and speaker-plug receptacle.

When the Service Man has tried all these remedies, let him consider the circuit Fig. 1A) of the first R.F. stage of this receiver. The small, panel-operated, vernier variable condenser C1 is connected to the grid of the '26 tube V1 through a switch, which is in the form of a blade and makes contact with the rotor plates when they are entirely out of mesh. This adjustment of the control shorts the grid of V1 to ground—and thereby cuts out the hum—while the signal input from the antenna is put on the grid of the second R.F. tube, which thus automatically becomes the first.

Rewiring this stage, as shown in Fig. 1B, will remove the hum from any Philco "87" that is in good operating condition. The wire from the switch of C1 to the "G" prong of the socket of V1 is removed, and a lead instead taken from the grid terminal of the antenna-coupling R.F. transformer L1. The stator of C1 is connected to the stator of C,

thus restoring the vernier to its task of shunting the tuning condenser. After this, it will be necessary to reneutralize the R.F. stages in the usual manner.

### "Fading" Problems

Fading seems to be one of the most serious conditions which the Service Man encounters with present-day A.C. sets.

It may be found, in a Zenith "50" chassis, that fading follows an adjustment of the vernier stator of the first R.F. tuning condenser; or there may be noisy reception. This "stator," being variable, requires a flexible connection to the grid terminal of the R.F. coil; the lead runs from the under side of the stator down through the chassis to the coil. Continual operation may loosen the soldered joint; or a cold-solder joint may have been made originally. To correct this defect, it is necessary to remove the metal shield from the gang.

A baffling case was that of a Peerless "Kylelectron" which would operate normally for half an hour, and then suddenly stop; only by switching the set on and off, several times, could the program be made to come in again. The first conclusion was that a condenser was defective; so the filter bank was replaced by one known to be in perfect condition. This did not help, nor did the replacement of all by-pass condensers. The chassis was interchanged with another pack,

the pack with another chassis; each combination was perfect when hooked up in another cabinet. This compelled the conclusion that the electrostatic speaker was defective. (See RADIO-CRAFT for December, 1929, and January, 1930, for a description of the operation of the electro-static speaker.) It was found that, after the set had been in operation for some time, the speaker would short at some point or another.

In some Peerless models, as in Radiolas "18" and "33", open by-pass condensers have caused uncontrolled oscillation. These sets have split primaries, on the R. F. transformers, and low-capacity condensers C are connected across sections of the windings (Fig. 2). Open condensers may cause noisy reception and shorted condensers, weak reception or none at all.

### Transformer Shorts

Analysis of a Stromberg-Carlson "846" showed a negative bias of 25 volts on one '45, and a positive bias of 160 volts on the other! When only the former tube was left in the socket, reception was obtained—though not ideal; there was no reception from the other '45. Since the biasing resistors were in perfect condition, and the secondary windings of the input push-pull transformers also, a continuity test was made between the primary and the secondary. It was found that  
*(Continued on page 236)*

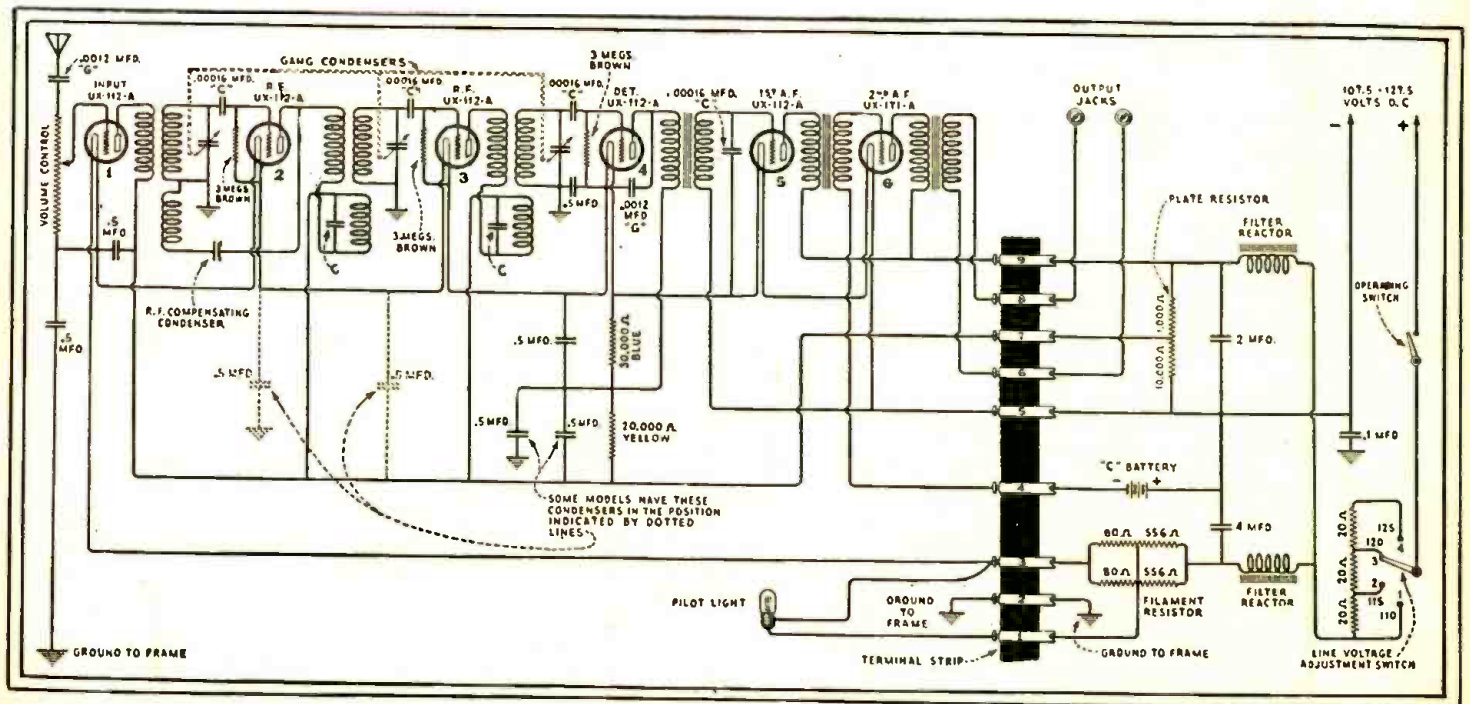

Fig. 2

This is the circuit of the Radiola "18 D.C." The Radiola 51 incorporates also a speaker. Observe the condensers C in the R.F. plate circuits. Similarly placed capacities are found in the Radiola "33" and some Peerless models.

# The "Stenode Radiostat" System

The invention which promises to revolutionize radio practice is explained here

By CLYDE J. FITCH

THE recent announcement that Dr. James Robinson, an English inventor, has perfected a receiver which gives high-quality reproduction of radio telephony on what is practically a carrier wave alone (the frequency "channel" required is stated to be but from 20 to 50 cycles wide, instead of the 10,000-cycle channel which is standard in the United States, or the 9,000-cycle channel used in Europe) has revived throughout radio circles the discussion of the much-mooted question of "sidebands."

Do sidebands in radio waves really exist? And, if so, what is their nature?

The answer is of the highest practical importance. Throughout the world, nations and individuals are endeavoring to increase the number of radio stations to the maximum which is practicable without causing undue interference and, in the case of broadcast stations, impairment of the tone quality of the reproduced voice and music.

To explain the points in controversy among radio engineers and physicists, as well as to describe the principle of the new invention, is the purpose of this article.

## What are Sidebands—If Any?

It was once customary, in the early days of radio, to think of a wave as having only a single frequency, with current and voltage variations proportional in amount or amplitude, to the audio-frequency impulses with

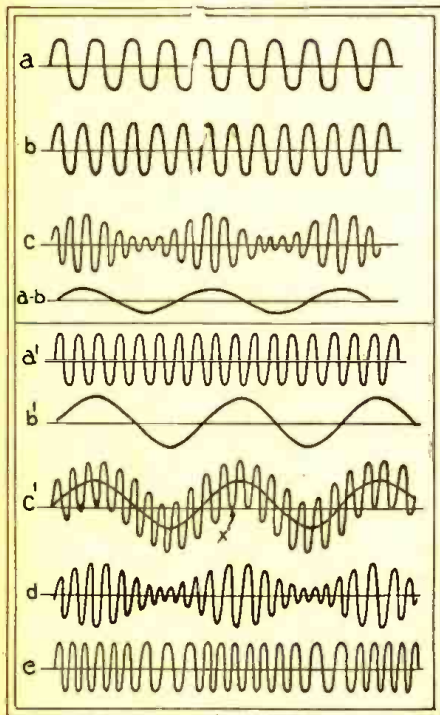

Fig. 1

The superheterodyne action above creates a beat-frequency  $c$ , as a transmitter creates a wave  $d$ , which is similarly modulated in amplitude. The "Stenode," on the other hand, uses a frequency-modulated wave  $e$ .

which it was modulated. But, after hundreds of stations came on the air, it was obvious that a station of one frequency interferes with a station on another frequency and that, when a receiver is tuned so sharply that the interfering station is cut out, something is lost also from the higher notes of the station to which the set was exactly tuned. We express this fact by saying that the loss of tone quality is due to "cutting sidebands."

The simple explanation, which satisfied most radio fans who could not go into the mathematics of the thing, is that: to the carrier-wave frequency there is added a whole band of frequencies on either side, which are equal numerically to twice the highest audio frequency used in modulation. That is to say, if a 1,000-kilocycle carrier wave is modulated by audio frequencies up to 5,000 cycles, there results a compound wave varying in frequency from 995 to 1,005 kilocycles and, consequently, 10 kilocycles wide. The five-kilocycle bands of frequencies, above and below the carrier frequency, were known as "upper and lower sidebands."

However, many radio engineers have never been satisfied with such an explanation; and others, admitting the existence of sidebands, saw no reason why they should be necessary in broadcasting. Sir Ambrose Fleming, inventor of the two-element vacuum tube, and a noted mathematical authority, doubts as to whether the sideband is anything but a convenient mathematical assumption, or has any real existence. Sir Oliver Lodge, the dean of radio research, says that a deep philosophical question seems to be involved.

However, let us consider the matter in the simplest possible manner:

## The Heterodyne Theory

Suppose we forget our old ideas of "modulated radio waves" and look at the situation from a different viewpoint. Take the superheterodyne; we know that the superheterodyne works, and we claim to understand its theory. Well then, apply the same theory to the radio broadcast station and our problem is partly solved. This idea was described by the writer, at some length, in the November, 1929, issue of RADIO-CRAFT.

In accordance with the heterodyne theory, which has been verified by the action of the many superheterodyne receivers now in use, when two frequencies  $a$  and  $b$  are combined, two others or "beat" frequencies are produced, namely,  $a+b$ , and  $a-b$ . Harmonics may also appear; but they are of no importance in this discussion.

It will be observed, when analyzing the superheterodyne circuit, that the beat frequencies  $a+b$  and  $a-b$  appear only after the frequencies have been passed through a detector—the first detector. This is shown in Fig. 1. Here the frequencies  $a$  and  $b$  are combined or mixed to produce the composite effect shown at  $c$ . After passing through the first detector, the beat or dif-

ference-frequency  $a-b$  appears. For simplicity, the sum-frequency  $a+b$  is omitted; as, usually, only one beat note of the superheterodyne is employed.

We can apply this theory to the broadcast transmitter, and thereby explain its action clearly. In the transmitter, we have the carrier frequency,  $a'$  combined with the audio frequency  $b'$ , producing the composite effect shown at  $c'$  (the frequencies are added algebraically on a graph paper) and this, in turn is converted into that shown at  $d$  by means of the limiting action of the transmitter's oscillating tubes. In other words,

SINCE radio broadcasting struck its stride, the ether has seemed too narrow for all who wish to put it to use. The system described here promises to make it possible to put a hundred stations on the air, where there was one before. Yet its adoption requires, not only special transmitters, but costly crystal-controlled receivers; and will therefore be a matter of time.

Still, it must come; and the alert radio man will therefore desire to familiarize himself with it at the earliest moment.

these tubes also perform a function similar to that of the first detector in a superheterodyne. The wave that leaves the transmitting aerial is therefore of the shape indicated at  $d$ . This is in accordance with observed facts.

Now if you will compare them, you will note that the wave shape at  $d$  is the same as that at  $c$ . Since  $c$  is composed of two radio-frequency waves, so also is  $d$ . Therefore  $d$  must have, in addition to the carrier frequency, another radio-frequency or "sideband" wave.

This reasoning, at least, ought to prove that sidebands exist. The next question is, are sidebands necessary?

## Demodulation

Of the four frequencies generated at the transmitter (namely the audio frequency, the carrier frequency, and the two sideband frequencies) all except the audio frequency are radiated into space. This is because audio frequencies do not radiate very far and the antenna system is not tuned to the audio frequency. Therefore, three frequencies reach the receiver in a form something like the composite group indicated at  $c$ .

If we should reverse the process, and subtract the various sideband waves from the carrier wave ( $d$  or  $e$ ) the result would be a single "sine wave," representing the unmodulated carrier wave of the station.

Therefore, if we took the sidebands away from the carrier by means of suitable filter circuits, the result would be an unmodulated

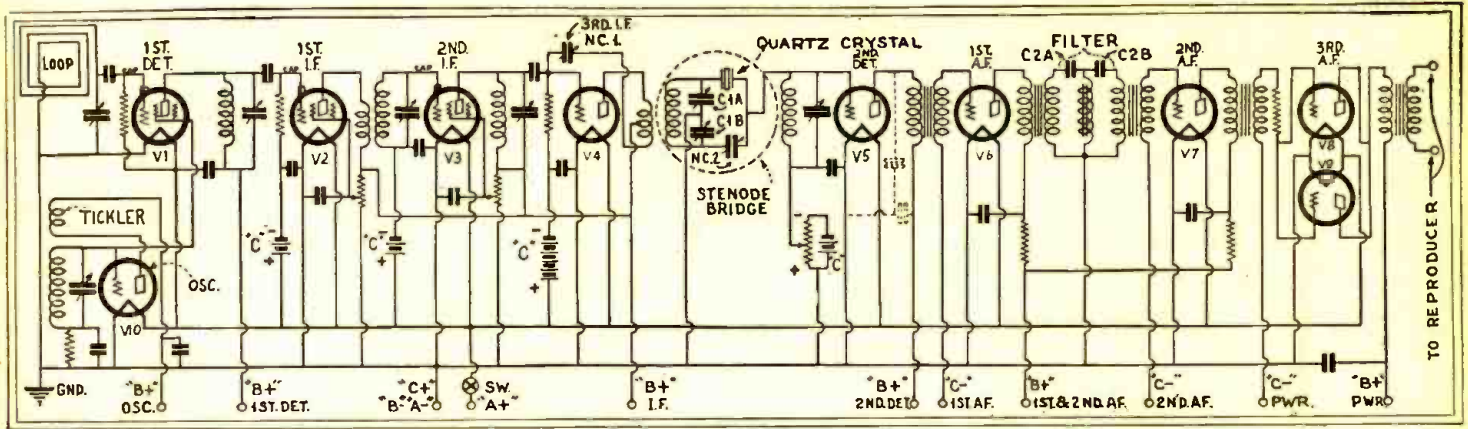

Fig. 3

The "Stenode" receiver above shown differs from ordinary superheterodynes in the circled filter, which accepts frequency variations not exceeding a hundred cycles. By the process indicated in Fig. 4, these are turned into a full band of audio frequencies.

carrier wave. In other words, removing the sidebands would demodulate the wave. Partial removal (as in a highly-selective receiver) would partially demodulate the wave, and result in poor tone quality. This is actually the case; there is no question about it.

It is safe to say that a pure sine wave has no sidebands, or harmonics. Altering the shape of the wave, no matter how, is the same as adding sidebands, or harmonics. Removing these sidebands or harmonics by means of filter circuits, brings the wave back to its original pure sine-wave shape.

Carrying our heterodyne example farther, at the receiving set both the upper and lower sidebands heterodyne with the carrier frequency, and produce beat-notes, which are intercepted by the detector and represent the original audio frequencies.

**Special Transmission Systems**

We can even suppress one of the sidebands at the transmitter; then let the other heterodyne with the carrier at the receiver, and produce the audio frequencies without impairing the tone quality. A single-sideband system of transmission was described in the June, 1925, issue of the *Proceedings of the Institute of Radio Engineers*.

We can even suppress one sideband and the carrier frequency also, at the transmitter, and radiate the other sideband only. In this case a new "carrier" frequency must be generated at the receiver, by means of a local oscillator, in order to produce the heterodyne effect with the received sideband. This oscillator-frequency must be exact; if it is too near the nearest sideband frequency, the audio-frequency beat notes will be too low. They will sound something like running a phonograph record slowly; except that the length of time required to complete the message is not reduced. If the oscillator frequency is too far from the nearest sideband frequency, the audio-frequency beat notes will be too high and a "tinny" sound will be the effect. If the frequency is on the wrong side of the sideband, the high audio notes will be low, and the low audio notes will be high. This is what is called "inverted speech"; the system has been demonstrated and described by Bell telephone engineers, and has been used in transatlantic telephony to obtain secrecy.

Now comes the demonstration of Dr. Robinson's "Stenode" (narrow path) system; and it has been hailed as disproving the existence of sidebands by its operation, ap-

parently without them. However, the receiver, which is demonstrated together with a transmitter made by the same inventor, depends upon the principle of "frequency-modulation" rather than that of "amplitude-modulation," which we have described as producing sidebands.

The idea of frequency-modulation is an old one—so old that patents issued on such a system have already expired. But there

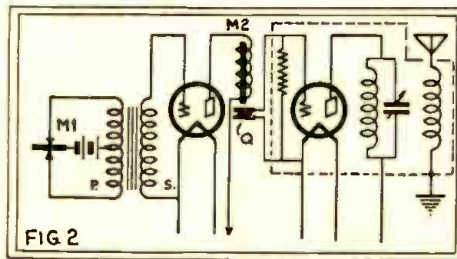

This diagram indicates the essential parts of the "Stenode" transmitter, the action of which depends on the variation of the capacity of the crystal Q and modulation thereby of the transmitted frequency. (Adapted from Die Woche.)

was then no commercial opportunity for its use. Several experimenters have worked on the possibility of a crystal-controlled receiver which would make possible reception of a greater number of stations, each on a frequency corresponding exactly to one to which the receiver would be held; this was discussed at the time of the institution of the Federal Radio Commission. But Dr. Robinson has incorporated the crystal control of the receiver into an intermediate-frequency amplifier, and thereby is able to receive many frequency-modulated transmissions with a single crystal.

**Frequency-Modulation**

Referring again to Fig. 1, at e we have the frequency-modulated wave; compare it with the amplitude-modulated wave d. In one, the current is constant in frequency and varies in amplitude or height. In the other, the current remains constant, while the frequency is varied; as shown by the varying distance between successive peaks.

How this is accomplished is shown in schematic form in Fig. 2, representing a portion of the Stenode transmitter. The speech currents, impressed through the microphone input on the amplifier, produce corresponding mechanical vibrations of a plate, which acts like a loud-speaker diaphragm operated by the electromagnet M2.

The width of the air gap separating the plate from the quartz crystal Q is therefore varied at audio frequencies; and this affects the period of vibration of the crystal, which is the master control of the oscillator tube. With this system, a very slight frequency-modulation is needed—only about 1/300th of one per cent., as will appear. The variations of the crystal's oscillating frequency are in this order.

At the receiving end, we find the superheterodyne circuit of Fig. 3. As stated above, the purpose of employing a double-detection circuit is to use a single quartz crystal to govern reception at all broadcast frequencies. Otherwise, it would be necessary to have a separate crystal for every station to be received—a physical and economic absurdity. In addition to this, it is almost impossible to bring two crystals so exactly into unison as would be required at transmitter and receiver.

The quartz crystal circuit acts as a highly-selective filter or "gate" (hence the name Stenode) through which only a very narrow band of frequencies may pass—less than a hundred cycles wide. If the received wave is of constant frequency, no sound will be heard from the speaker; but if it is varied in frequency, at intervals comparable to the periods of audio frequencies, a response will be heard.

Consult Fig. 4. Here we have the selectivity curve of the quartz crystal of the (Continued on page 237)

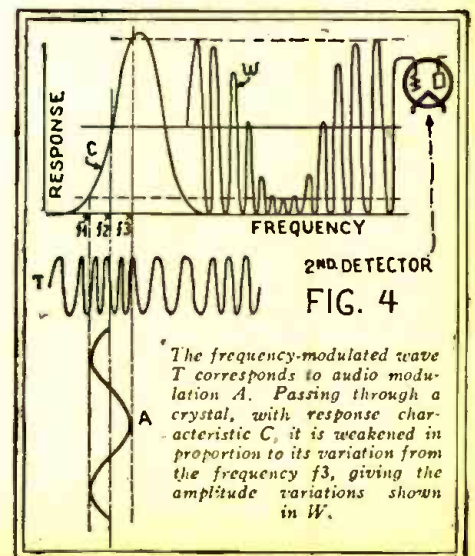

The frequency-modulated wave T corresponds to audio modulation A. Passing through a crystal A, with response characteristic C, it is weakened in proportion to its variation from the frequency f3, giving the amplitude variations shown in W.

# Television in Twelve Colors

*Ingenious novelties developed by European experimenters in the popularization of "sight-at-a-distance"*

By DR. FRITZ NOACK (Berlin, Germany)

**T**HE success of colored motion pictures, for which special films are prepared, suggests the application of somewhat similar methods to television. However, colored television necessitates either a special wavelength for each color employed, or else modulating the transmissions at twice or three times the normal image frequency. Either widens the waveband to an extent which is prohibitive.

In addition to this, the superposition of two or three pictures, each in a single color, does not give an absolutely natural effect; because the spectrum of visible light is much more complex.

Then, too, the methods of colored television heretofore published are in principle exactly like those used in black-and-white reproduction. The different image points, varying in illumination, are converted into corresponding electrical impulses at the transmitter; they must be faithfully and exactly reproduced at the receiver, to have a perfect picture. But there are many causes of faulty reception, the most unpleasant of which is fading; not only does this cause interruptions of reception, but it also suppresses parts of the transmission, corresponding to certain frequencies. In a loud speaker, this means that sounds are lost or changed in timbre; in a televisior, that details may disappear entirely.

## Equal-Illumination Signals

The effect of fading may be overcome in telegraph work by employing such a modulation that the signal swings back and forth

between zero and a fixed value. This, for instance, is done in the transoceanic short-wave work of the Telefunken Co.; a receiver of amplification so high that the signals never disappear entirely is connected to recording apparatus through an automatic volume control. This, of course, is impossible in telephony, where variation of loudness as well as frequency is part of the signal; and it is also unsuited to television, where we must reproduce different light-values. If a process of scanning should be adopted, in which pictorial points of the same intensity are always selected, then fading could readily be overcome.

Dr. Schroeter, of the Telefunken Co., has made the suggestion that the image points be distinguished not by reproducing them at equal intervals with varying intensity, but by giving them the same brilliancy for varying periods of time; just as in telegraphy dots and dashes of the same strength are sent out, instead of dots of varying strength. In order to make this practical, it will of course be necessary to invent a method of converting the image from points of varying brilliancy into dots and dashes representing the same light values in terms of length.

However, a television system has been announced, which overcomes these difficulties and makes color television possible without widening the waveband, without fading and with the greatest fidelity to nature. It is that of a Berlin engineer named Ahronheim, who has lately acquainted me with its details.

## Twelve-Color Discs

It is based upon the assumption that the colored image points show, not different intensities of light, but different color tones; that dark red and light red are not merely reds of different intensity but, actually, different colors. His methods of scanning the image are the same as in previous systems; the novelty lies in filtering the light before it enters the photo-cell, according to its place in the spectrum. The visible spectrum contains many gradations of color, but Ahronheim undertakes to reproduce it with twelve.

Then, if a revolving disc is arranged with colored glass sectors (Fig. 1) through which the light must pass from the scanning apparatus to the photo-cell, the ray of light can penetrate only the filters of appropriate color. The scanning mechanism operates as in other systems; and the filter disc only must revolve at higher speed, to make up for the fact that the light ray penetrates only one of its sectors at each revolution.

At the receiving end, a suitable system of scanning is used to build up the image; but here also a glass filter with twelve sectors is placed between the source of light and the eye of the observer. If the two discs are synchronized, a picture corresponding most exactly to the image at the transmitter will be seen.

Since the photo-cell receives just as many impulses as with black-and-white telegraphy, the modulating frequency required is no higher for colored television; and if the transparency of the filter is properly regulated, the image impulses in the input of the transmitter, and the signals it sends out are of uniform intensity.

## Use of a Prism

However, Ahronheim proposes, not to build a mechanical filter system of the kind described above, but to utilize a prism which, as we well know, decomposes white light into its constituent colors. The entire spectrum will come out only when light has been directed into the prism; light of a single color will emerge unchanged. Since the light rays are dispersed at different angles, according to their wavelengths, we could arrange twelve photoelectric cells side by side behind a prism; so that one would receive all the dark-red light which entered the prism, another all the light blue, etc. In practice, only one cell will be used, however; and, by the use of a scanning device, only the color corresponding to the image point reproduced at the instant will be conveyed to the cell.

The model at present completed is arranged for but a few color tones; but it demonstrates the fundamental characteristics of the invention. It is especially well adapted for televising colored motion-picture film, and it is possible to transmit simultaneously from the sound track. It is understood that an international moving-picture organization is interested in the invention.

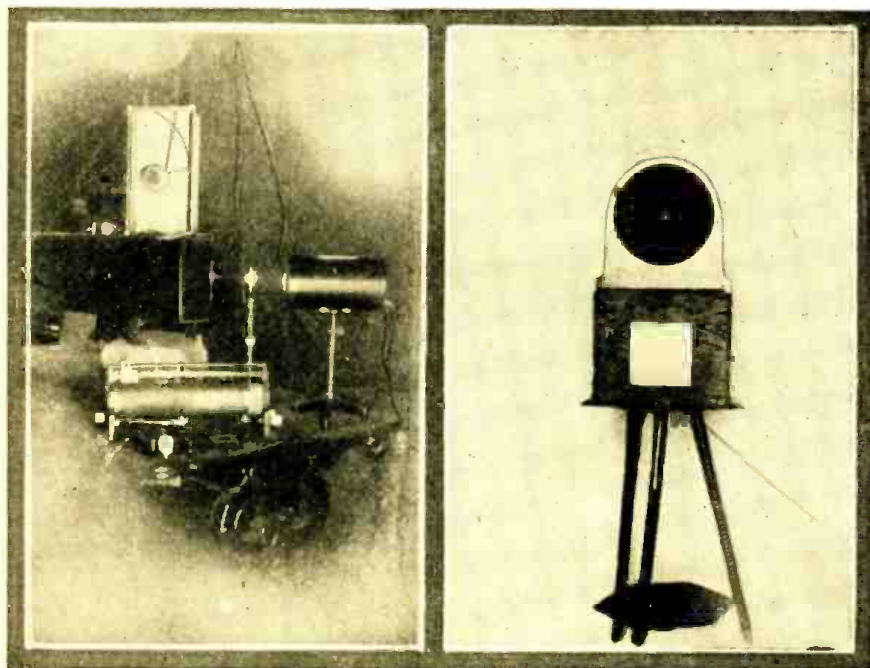
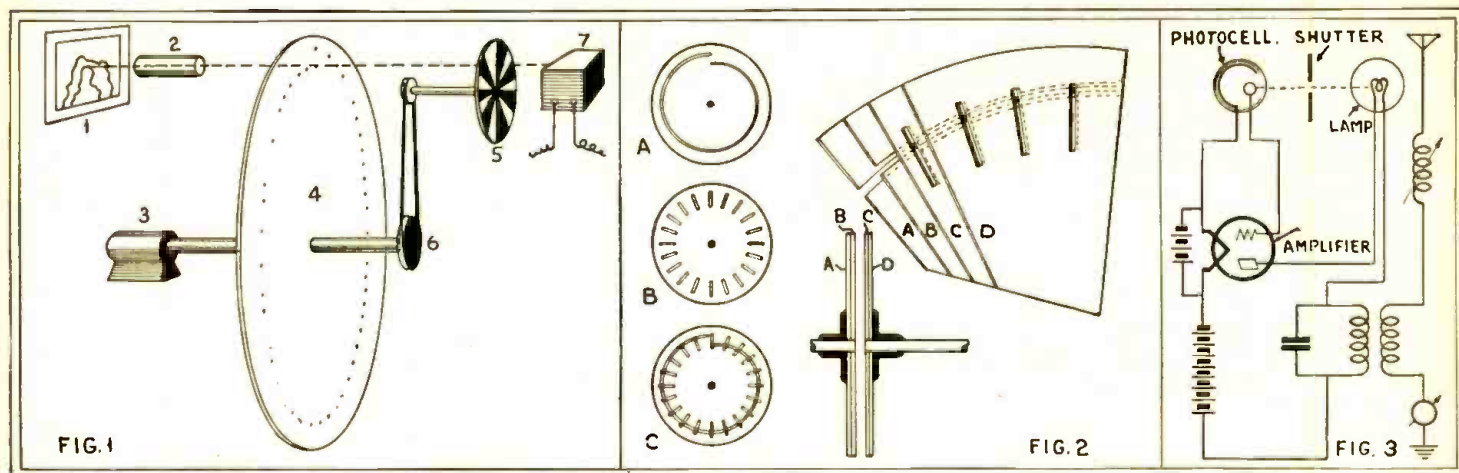

Fig. A

Fig. B

At the left, the experimental transmission set-up of the Ahronheim apparatus, by which it is planned to pick up television images in their natural colors, as determined by the dispersion of white light into its various frequencies. At the right, the receiver of the Ahronheim apparatus, with a loud speaker above and the image-screen below.



(Left) Fundamental principle of the Ahronheim system: light from the image 1 is concentrated by lenses 2 on the scanning disc 3; but reaches the photo-cell 7 only when the proper filter is presented by the disc 5, which is geared (6) to revolve faster than the scanner. (Center) The Fries universal scanner: it will be seen, at the left, that A and B combined as at C give a spiral of square holes. Four discs, two spiral (A-B) and two slotted (C-D), at the right give any desired "grain" to the image; and revolving them on two shafts as shown below gives any desired scanning rate. (Right) Optical regeneration is produced by flashing the impulses of the photo-cell back into it from the lamp.

**Universal Television Receiver**

At the present time, the English and German television transmissions are extremely interesting to radio enthusiasts. However, the systems used differ in details; the German transmission are made at the rate of 750 thirty-line frames per minute, framed at the top of the disc; the image is a third



**Fig. C**

A commercial German television, on the Mihaly system, as produced by the Telehor Company.

wider than it is high. In the English (Baird) system, while the number of lines and rate of speed are the same, the image is viewed at the side of the disc, and it is higher than it is wide. Since this presents complications to the set owner, a method of adapting a radiovisor to different systems will be valuable.

In America, where several types of transmission are in use, it has been proposed to pierce the scanning disc with several spiral rows of holes, at different distances from the center; this also makes it necessary to shift the glow lamp and "window" for each reception. In addition to this, the images received nearest the center of the disc must be smaller.

The use of separate discs entail unpleasant labor in interchanging them, which would be too much of an annoyance for the set owner who purchases his equipment.

However, the new Fries system overcomes all these difficulties. Radiovisors using this method have already been produced commercially. The simplest, intended for the present transmissions by English and German broadcasters, have two picture windows and two rows of holes in the disc; the regular glow lamp is used. The holes for the English transmissions are on radii midway between those for the German; since there

are thirty of each; but the pitch of the spirals is different. Only one glow lamp is required.

To prevent the two sets of holes from causing optical interference, a special disc is used to cover one of them. It has a set of 30 slits, and may be turned on the axis of the main scanning disc to uncover one or the other spiral; it is then clamped tightly to the main disc. The English image, received sideways at the top of the disc, is made to appear right-side-up by the use of mirrors.

**Four Discs Required**

However, the inventor has carried his idea to the point of making it possible to receive transmissions on other systems, with holes of different numbers and different sizes. He accomplishes this, as shown in Fig. 2, by the use of four discs—two pairs of which are alike. Two of these have spiral holes and two have radial slits; the latter pair 20 each, presumably the least number of pictorial lines which will afford an image.

One disc of each pair is keyed to the axle, while the other may be turned, as before, to open or close the slits, before clamping it to its mate. The result is, that the holes apparently produced by the passing

(Continued on page 238)

**Men Who Have Made Radio—Count Georg von Arco**

**THE THIRTEENTH OF A SERIES**

THE inventor, like the scientist, is often popularly imagined to be an impractical recluse with an artistic temperament, lacking in business sense and in the ability to make his ideas appreciated. On the other hand, we often hear the assertion that the typical business mind, like the military mind, is closed to revolutionary technical ideas, and resists their introduction to the last. It may be that the exception proves the rule; but certainly, where the inventor and the executive are joined in one forceful personality, the results are conspicuous—and in none of the great pioneers of radio more strikingly than in the case of Germany's leader in the development of the art. This distinguished

veteran is Count Georg von Arco, whose picture appears on the cover of this month's RADIO-CRAFT.

Count Arco, who was born at Grossgorschütz, in upper Silesia, August 8, 1869, was of a mechanical bent, even as a boy. After graduating from the classical "gymnasium" (preparatory school) of Breslau, he entered the University of Berlin to study science and mathematics. After brief service as an army officer, he turned from this profession, for which family traditions would have destined him, to seek his true vocation in the field of technical development. After further studies and some practical experience, he found before him the new and attractive subject of wireless telegraphy; which enterprising scien-

tists throughout Europe were endeavoring to perfect under the pressure of national as well as individual rivalries. Arco, associating himself with Slaby, soon became one of the triumvirate of German radio pioneers, the third of whom was Braun. In 1898 he devised an improved transmission circuit; and soon the Slaby-Arco system had acquired world-wide fame. It was adopted quickly by Germany, and then by Sweden, for naval use. The German government urged the co-operation, rather than competition, of German wireless interests to present a united front to external rivals; and the final result was the organization of the radio-communications corporation known universally today as

(Continued on page 239)

# SHORT WAVE CRAFT

## The Short-Wave Superheterodyne

By L. W. HATRY

**T**HE double-detection (superheterodyne) circuit has gained its reputation as an excellent performer by the possession of three advantages which are just as valuable for short-wave work as in 200-500-meter reception. A set using the "D.D." (double-detection) circuit, assembled from standard parts, is certain to be easily constructed and adjusted, highly sensitive, and easily operated.

But a receiver of this type, designed for use on frequencies up to 15,000 kilocycles or higher, differs in several details from the broadcast superheterodyne. The latter, if of the most recent design, has a screen-grid first detector, preceded by one or more stages of tuned R.F. amplification, which have been included to obtain in the presence of strong local signals, the extreme selectivity, required in crowded metropolitan area. While the short-wave super has also a screen-grid tube as the first detector (but with a "space-charge" connection) it need not develop into a hybrid T.R.F.-super. Its greatest problem is the handling of weak or medium signals, and for these the D. D. circuit assures high selectivity.

Similarly, the broadcast and the short-wave sets both include screen-grid intermediate-frequency amplifiers; but the frequencies selected for them will not be the same. The broadcast set should have an amplifier tuned to a frequency between 50 and 450 kc. (depending upon its purpose and construction); while the frequency used

in the intermediate amplifier of the short-wave super should not be much lower than 1400 or 1500 kc.

And, while the broadcast set may well employ a power second-detector with a single stage of audio, the short-wave receiver, being designed primarily for extreme sensitivity, requires a regenerative second detector which operates most smoothly on low voltages, with a grid leak and condenser. Such a detector has a limited undistorted output and, therefore, must be followed by two or more audio stages if the receiver is to give an output of sufficient strength for good loud-speaker operation. Several reasons exist for these differences in design; but first let us review the reasons for the great sensitivity and selectivity of the double-detection circuit.

### Simplicity of the Superheterodyne

The conventional T.R.F. broadcast receiver, employing a radio-frequency amplifier tuned throughout to the frequency of the incoming signal, does well on frequencies of 1500 kc. down; while a similarly tuned R.F. amplifier progressively loses its efficiency on increasing frequencies until, at about 20,000 kc., it virtually ceases to amplify.

In the double-detection receiver, however, the intermediate amplifier functions at only one frequency, to which the incoming signals are converted, regardless of their original wavelength. Consequently, when the am-

plifier has been tuned to a frequency at which it is efficient, it retains that efficiency, whether the signal is received at 1500 or at 30,000 kc.

Furthermore, in a T.R.F. short-wave receiver, using plug-in coils, increasing the R.F. amplification adds proportionately to

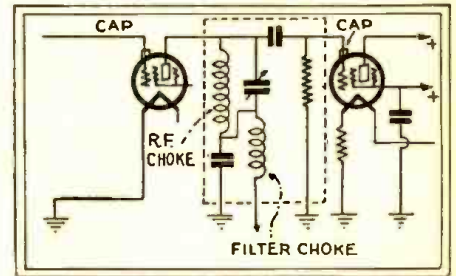

Fig. 3

*One of the coupling units used in the intermediate amplifier designed by Mr. Hatry. The high impedance required by the screen-grid tube is provided by the tuned-plate circuit.*

the number of coils; that is, for five wavebands, every added R.F. stage necessitates five more coils to be handled. But a D.D. short-wave set requires only two coils in each set (one for the oscillator and one for the first detector), no matter how much we multiply the stages of amplification.

Similarly, except in the D.D. receiver, increased amplification necessitates either increased complexity of control, or inordinate expense to maintain the precision of ganging in manufacture.

In brief, therefore, the sensitivity of the D.D. circuit comes from the convenient and effective use of several stages of (intermediate) R.F. amplification, giving practically uniform step-up throughout the signal-frequency range of the receiver. Since tuned circuits are commonly used in this cascaded amplification, a great selectivity, practically uniform throughout the range, is obtained in the intermediate amplifier.

Another advantage is the ease with which a superheterodyne is tuned. The difficulties experienced with the ordinary four-tube short-wave set (one R.F. stage, regenerative detector, and two stages of A.F.) have become almost proverbial. Magazines have devoted pages to labored instructions for the short-wave novice, without greatly reducing his period of apprenticeship—usually from two weeks' to two months' practice. The difficulties are due, mainly, to the critical nature of the adjustments necessary to obtain the best results.

On the other hand, the D.D. outfit has no single critical control and, however prod-

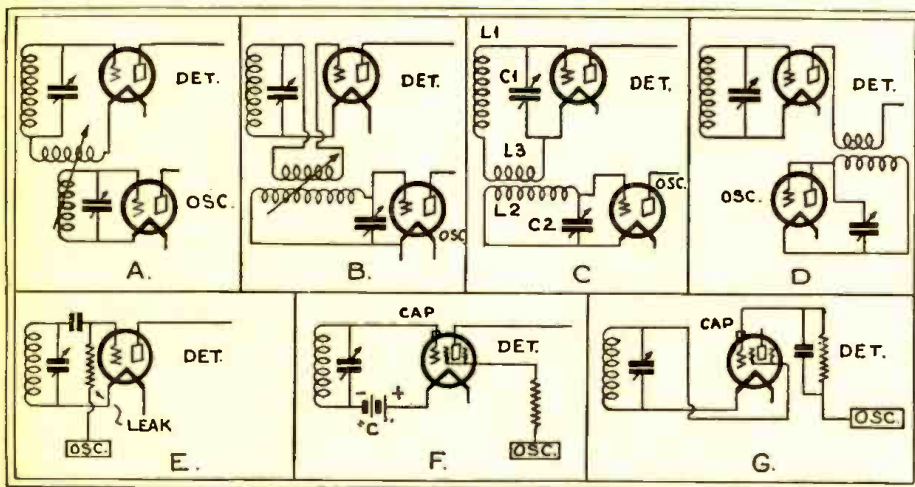

Fig. 1

*This diagram shows at a glance the numerous methods of coupling which may be employed to introduce the locally-generated oscillations into the circuit of the first detector. They are self-explanatory; but it is commented that C, where the coupling takes place in the tuned input circuit L1-L3 of the detector, is the worst; while that of G is highly satisfactory.*



gally tubed, can have but two tuning controls. This means ideal simplicity for the C.W. (continuous-wave telegraphy) enthusiast, almost the ultimate in control for the new short-wave broadcast listener, and a great relief to the dealer or set builder who does not wish to spend two months in the education of a beginner, in order to sell a set.

**Elements of the Superheterodyne**

It is well known that a double-detection receiver or circuit comprises five elements: a first detector, an oscillator, an intermediate-frequency amplifier, a second detector and an audio-frequency amplifier.

The first detector is otherwise known as a modulator, a converter, or a mixing tube. Since what may be called "modulating," and what certainly is "mixing," occur in this tube, these terms may be accepted; but since the tube should rectify, and thus separate from the incoming signal frequency and the locally-generated oscillator frequency a third (intermediate) frequency—it must be considered as a detector.

This first detector drops off noticeably in efficiency, at high frequencies, when used with a grid leak and condenser; therefore grid-bias detection is desirable.

Finally, this tube must be a good amplifier. While the screen-grid tube has an enormous output impedance when used as a bias detector, it is difficult to transfer a signal through it, even with a tuned circuit as the load in the plate circuit; but it can be used as a space-charge detector and maintain a high amplification factor with a reasonable impedance. The space-charge grid-bias detector therefore is indicated.

**The Oscillator**

The oscillator has the simple task of generating the current which "beats" the signal, and will presumably supply more energy than is needed. The circuit used is comparatively unimportant; and its efficiency is negligible, if oscillation is obtained. Such rugged and long-lived tubes as the '01A or '12A are suitable.

The method of coupling the oscillator to the detector, in order to secure the proper mixing or beating action, presents a problem. Several possibilities are shown in Fig. 1, though each presents certain disadvantages.

For instance, that shown at C is very critical as to the number of turns required in the pick-up winding, PL, at different frequencies. If L-C tunes, for instance, from 3000 to 5000 kc., PL should be four turns. But, if we change the inductance L to cover a slightly higher range, the number of turns in PL should be reduced; as also if the oscillator should generate R.F. current more vigorously than expected. Down near 20 meters, PL can be critical to a quarter-turn and occasion a nightmare of adjustments and trials.

In addition, this circuit permits the tuning of the detector and the oscillator to "interlock"; that is, the adjustments of C affect those of C1 and cause a signal to come in at different dial combinations. This is intolerable. For this reason, circuit C is given as a horrible example.

On the other hand, the circuit shown at G overcomes both these difficulties and greatly simplifies preliminary adjustments.

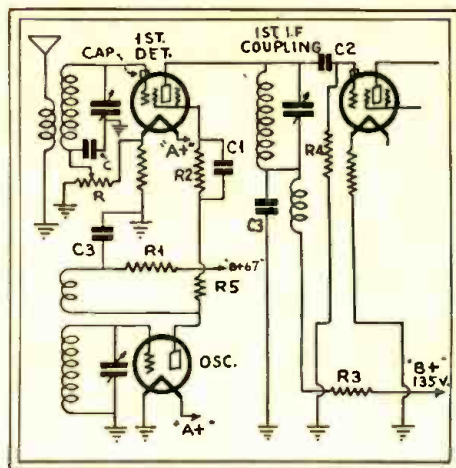

**Fig. 2**

An arrangement suitable for coupling the first detector, oscillator, and first I.F. circuits in a short-wave superheterodyne. C, .01-mf.; C1, .00025; C2, .0005; C3, 0.25; R, 50,000 ohms; R1 and R5, 2,000; R2, 100,000; R3, 50,000; R4, 2 meg.

Here the oscillator's radio-frequency energy, instead of the usual 45- to 67-volt D.C. potential, is placed on the space-charge grid of the detector, and thus modulates or beats the signal; interlocking is prevented and effective performance is made possible over an enormous frequency-range.

**The Intermediate Amplifier**

In the intermediate-frequency amplifier, which takes the output of the first detector, it is desirable to use a minimum of tubes to obtain high amplification, and the screen-grid types are therefore desirable. To match the high impedance of the '22 and the '24, the use of tuned circuits in their plate returns is most satisfactory. We shall therefore use the impedance couplers (shown in schematic form in Fig. 3) between stages. To design the coil is easy, in view of the great mass of published data available; but we must first select our intermediate frequency.

We know that a frequency range of 550-1500 kc. (the broadcast range) is successfully covered by the screen-grid tube as an amplifier; but if we choose our intermediate frequency in that range, it is apt to treat broadcast signals too well and make a source of interference of them. So, we choose, say 1550 kc. as an intermediate frequency which will permit tuning ranges of 3000 kilocycles each without repeat points

on the dial; and, in being forced to limit our tuning ranges, we shall gain the advantage of equal frequency-bands from 20 meters to 150, so that tuning will be as easy at one as the other. In addition to this, a high intermediate frequency has the advantage of increasing the selectivity of a set in the presence of strong signals.

The number of stages of intermediate frequency amplification is determined by several things: the effectiveness of the shielding; the permissible outlay; and, also, the needed degree of selectivity. For most practical purposes, normal economy, and normal selectivity requirements it will be found that two or three stages of I.F. amplification take care of the usual volume-sensitivity demands.

We previously passed over the problem of tuning bands, in order that it might be fitted into a more suitable place. We can gauge our tuning bands by our intermediate-frequency; for instance, if the latter is 1500 kc. and the tuning range covers 3000 kc., it is possible to use the same tuning coil in the oscillator for the 2,500- to 5,000-kc. and the 5,000- to 8,000-kc. bands. This, because the repeat, or second tuning, point is actually utilizable when the selected intermediate frequency is high enough. This simple stunt reduces, to just one half, the number of plug-in coils required for the oscillator. Also, 3,000-kc. bands will permit covering the 17-1000-meter range, the most useful portion of the short-wave region, with a total of six detector and three oscillator coils (or, if we desire greater spreading of tuning, 1,500-kc. bands may be chosen, and the total number of coils doubled.)

The writer has touched but lightly on the method used in determining the best intermediate frequency; this is an involved problem which will require considerable space to explain properly and must, therefore, be discussed at a later date.

**Audio Quality Problems**

The design of the second detector is dependent upon whether it is to meet the demands solely of the short-wave broadcast listener, or those of the short-wave telegrapher.

In the first instance, good tone and simplicity of operation are required. Good tone, of course, is largely determined by the such as the '12A, is needed; it should also audio amplifier. A non-microphonic tube,

(Continued on page 240)

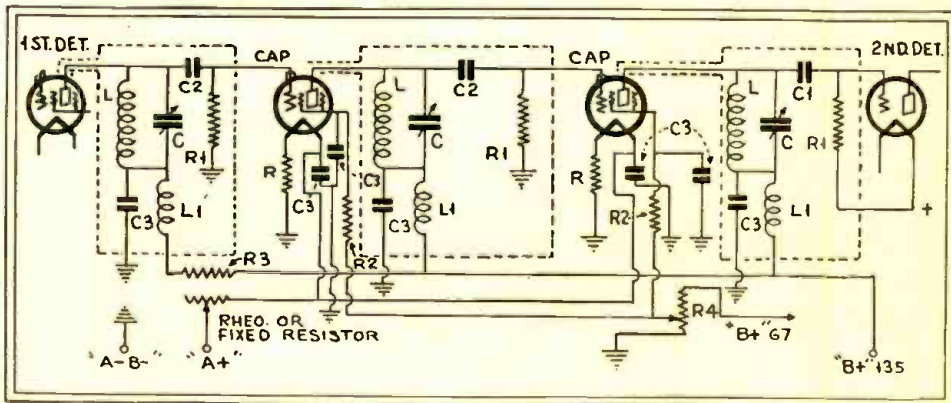

**Fig. 4**

A complete I.F. amplifier: L, each 150 turns No. 30 D.S.C., 1-in. form; L1, R.F. chokes; C, .0001-mf. "Equalizer"; C1, .0002; C2, .0005; C3, 0.25; R, 15 ohms; R2, 2,000 ohms; R3 and R4, 50,000 ohms; R1, 2 megohms.

# The "Universal" Broadcast Receiver

*An elaborate set which makes it possible, by selective switching, to tune in from the panel any broadcast range, short-wave or long*

By SAMUEL WHISK

**I**N an unguarded moment, the writer accepted the contract to design and build a receiver which would get (within reasonable limits) any broadcast station on the air, whether operating on the upper band from 200 to 550 meters, or on the short waves which are becoming increasingly important.

The result of his ensuing mental turmoil is the "Universal" broadcast receiver here pictured and described. The front and rear views appear below; the diagram of connections is Fig. 1.

## Details of the Design

Go ahead and count the tubes—everyone does. There are thirteen, including the pilot lights and the rectifier; if the constructor, or his customer, is superstitious, let him use one less pilot light, or one more.

The first problem to be solved was that of obtaining maximum signal strength from all stations, at moderate cost. For operation on the upper waveband, it is obvious that a number of R.F. amplifier tubes are required; while, from the nature of short-wave reception, only one or two ahead of the detector would be required. Experiment showed that, in fact, one R.F. stage is sufficient for reception, in Brooklyn, New York, of short-wave broadcast programs from London, England; Eindhoven, Holland; Paris, France and Berlin, Germany—to say nothing of our own West Coast and the growing number of short-wave broadcast stations in Central and South America.

On the other hand, practically the same degree of audio amplification is desirable for all signals; but, because of the difference in

the type of detector circuits, it was necessary to use different methods of coupling to the first audio stage. For that reason, the short-wave side of the receiver has its individual first stage of audio; coupled to its detector by a capacity and resistance (C24-R13, in the schematic circuit). This precaution averts circuit instability and loss of audio quality in the reproduction of short-wave programs. When the short-wave tuner is in operation, therefore, it utilizes the tube V11 as the first audio stage; and therefore V5, which serves the same purpose in longer-wave reception, is unused. The plates of these two tubes are connected directly to the input of the audio transformer T2.

## Selectors and Volume Controls

To simplify operation for the owner of the receiver, and spare him the task of changing coils, two switches (Sw5 and Sw6) were provided to select the appropriate tuned-impedance coupler between the periodic short-wave R.F. amplifier V9 and its detector, V10. These two switches control the grid and plate connections to the five inductors L5-6-7-8-9; these cover the short-wave range from 16 meters up in five bands which overlap very slightly when tuned by the .00014-mf. condenser C20. (In later models, Mr. Whisk is arranging to combine these two switches into one control, for greater simplicity in operation.—*Editor.*)

While, for operation on any wave, the volume of the signal is controlled by varying the bias on the screen-grids of the R.F. stages (by means of the 50,000-ohm potentiometer R3), in the short-wave tuning unit the control of this resistor over the bias of

**T**HE author of this article is a custom set builder with a deserved reputation for executing the most difficult pieces of work and solving the problems of those who want individual installations de luxe. The "Universal" receiver described here is a forerunner of many which will give the exacting patron an easily-operated set that will pull in the programs on all waves—and, be it remembered, the short-wave broadcasts have extended the range of broadcast reception over a band more than twenty-five times as wide as our "standard" 550-1500-kilocycle range! It is of interest to learn that Mr. Whisk is now completing a universal-range broadcast receiver which will take in also the European long-wave broadcast range up to 2000 meters; having single-control tuning and a built-in televisor which will reproduce images while sound is being received on its speaker. This, of course, is intended for export to the Continent—after it has been exhibited to the radio students at Columbia University in this city.

V9 is supplemented by the use of the 23-mmf. regeneration condenser C21. On the longer waves, control of the voltage on the screen-grids of V1, V2 and V3 is further supplemented by regulation of the control-grid bias of the detector V4, obtained by varying the 10,000-ohm cathode resistor R2.

While the rear view of the "Universal" presents an apparently indistinguishable mass of wiring, care was taken in the construction to twist leads wherever necessary and to arrange them in such manner that the minimum of undesirable coupling exists.

The writer (having been brought up among seafaring associates) insisted upon giving a proper nautical touch to his creation by the employment of red and green pilot lights in the conventional arrangement—the former on the port side, and the latter on the starboard. These derive their current from a separate transformer, to avoid placing additional load on the filament circuits. The decorative possibilities of an extension of this idea will appear at once to the constructor. Two lamps might be wired, so that the color would indicate whether the set is adjusted for long- or short-wave reception; or four might be so connected that the change-over would make them seem to exchange places.

## List of Parts Used

- One Pilot single variable condenser, .00035-mf. (C1);
- One Pilot 3-gang variable condenser, .00035-mf. per section (C2, C3, C4);
- One Dubilier .002-mf. fixed condenser (C5);

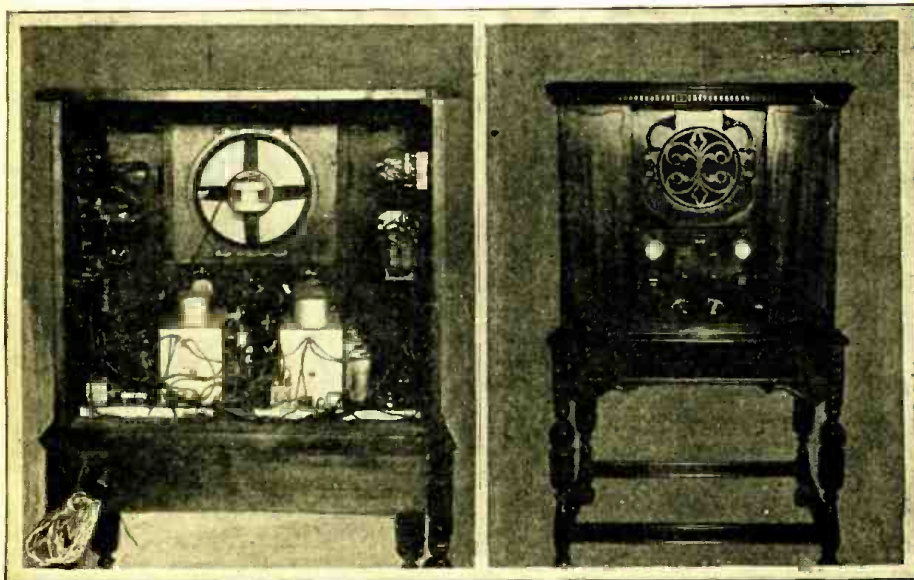

Fig. A

Fig. B

At the left, the apparently random wires of the Universal receiver; the R.F. units on either side of the center, below, and the reproducer above, while on either side of the console are mounted power supply-equipment. At the front, a view of the handsome cabinet, with its two condensers, meters and the two switches selecting wavebands. It is not an inexpensive job, but one built to the requirements of an owner who desires something not commercially available.

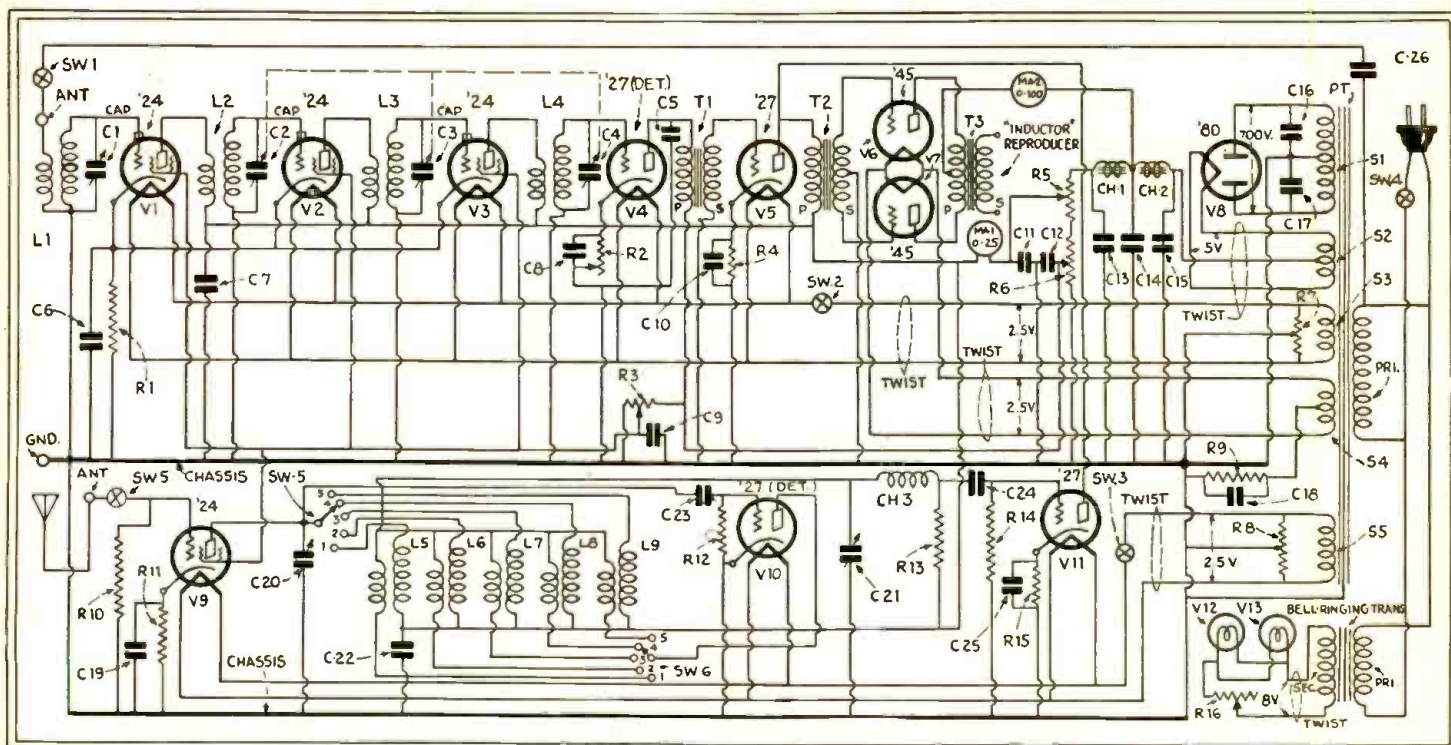

Fig. 1

This circuit is not the most elaborate in the "Universal" receivers made by Mr. Whisk; he has devised one of 19 tubes, containing a television lamp, for sight-and-sound reception. The long-wave tuning unit is shown at the upper left and the short-wave receiver, with its selector switches and coils for five wavebands, at the lower left. Each has its own first audio stage, feeding the '45 push-pull power stage. The pilot lights are in a separate filament circuit; although this may be modified according to the constructor's ingenuity.

- Two Electrad 0.25-mf. fixed by-pass condensers (C6, C7);
- Two Flechtheim 1.0-mf. by-pass condensers (C8, C10);
- One Flechtheim 0.25-mf. by-pass condenser (C9);
- Two Flechtheim 1.0-mf. filter condensers, working voltage 450 (C11, C12);
- Three Flechtheim 2-mf. condensers, working voltage 650 (C13, C14, C15);
- Two Aerovox 0.1-mf. filter condensers, working voltage 1000, for buffers (C16, C17);
- One Aerovox 2-mf. by-pass condenser (C18);
- One Flechtheim 0.25-mf. by-pass condenser (C19);
- One U.S.L. 0.00014-mf. 7-plate variable condenser (C20);
- One Pilot 0.000023-mf. 23-plate "midget" variable condenser (C21);
- One Flechtheim 1.0-mf. filter condenser, working voltage 450 (C22);
- One Aerovox 0.0001-mf. fixed condenser (C23);
- One Dubilier .01-mf. fixed condenser, working voltage 300 (C24);
- One Flechtheim 1.0-mf. by-pass condenser (C25);
- One Clarostat Antenna Plug (C26);
- One Clarostat 250-ohm biasing resistor (R1);
- One Clarostat 10,000-ohm variable resistor (R2);
- One Clarostat 50,000-ohm variable resistor with variable tap (R3);
- One Clarostat 2,000-ohm fixed bias resistor (R4);
- Two Electrad 15,000-ohm resistors with variable tap (R5, R6);
- Five Hammarlund screen-grid tube shields (for V1, V2, V3, V4, V9);
- Two Aluminum Shield Cans, 5 x 9 x 6 in.;
- Two Pilot 20-ohm center-tapped resistors (R7, R8);
- Four tube caps (coil shields), 3 in. x 4 in. high;

- One Electrad 750-ohm bias resistor (R9);
- One Durham 1-meg. grid leak (R11);
- One Clarostat 450-ohm bias resistor (R12);
- One Durham 3-meg. metallized grid leak (R13);
- One Durham 1-meg. metallized grid leak (R14);
- One Clarostat 2,000-ohm bias resistor (R15);
- One Ainsco 20-ohm rheostat (R16);
- One Readrite 0-25-scale milliammeter (Ma1);
- One Readrite 0-100-scale milliammeter (Ma2);
- Two Ford mica "type 245" filter chokes (Ch1, Ch2);
- One Ford mica power transformer (PT);
- One Hammarlund R.F. choke, "No. 85" (Ch3);
- One Ford mica 1 : 1 ratio "super" A.F. transformer (T1);
- One Ford mica 1 : 1 ratio "Super" A.F. push-pull A.F. transformer (T2);
- One Ford mica 1 : 1 ratio "Super" output push-pull A.F. transformer (T3);
- Two snap switches (Sw1, Sw5);
- Two panel mounting push-pull "off-on" filament power switches (Sw2, Sw3);
- One push-pull switch (Sw4);
- Two General Radio 6-point inductance switches (Sw5, Sw6);
- Five Eby sub-panel mounting 5-prong tube sockets, for V1, V2, V3, V5, V9;
- Three Benjamin 4-prong "red-top" cushion sockets for V6, V7, V8;
- One Benjamin 5-prong "green-top" cushion socket for V10;
- Two Eby base-mounting 5-prong sockets for V4, V11;
- Two Marco Vernier Dials;
- One Stettner "Model 90-B" cabinet;
- Miscellaneous Hardware including 6-volt pilot lights (V12, V13); miniature sockets, red and green indicating bulls-eyes and a bell-ringing transformer.

Observe that two milliammeters are incorporated in this receiver. The 0-25-scale instrument Ma1 is used to check the plate supply to the amplifiers and the detector V10; the 0-100-scale meter Ma2 shows the plate current of the '45 power tubes V6 and V7. The two together afford a quick and effective means of testing the circuit in case of a breakdown.

**Coil Data**

The coils for the upper waveband are contained in the small cans which appear like caps on the regular stage shields. The short-wave coils are mounted as shown in Fig. 2. The "Class A" (200-550-meter) inductances have secondaries of 110 turns each of No. 30 S.C.C. wire, on forms 1 1/4 inches in diameter. L2, L3 and L3 have primaries of 46 turns each over the filament end of the secondaries, from which they are separated by a strip of celluloid; L1 has a primary of but 12 turns, for the aerial circuit. Both windings are in the same direction; the end of the primary nearest the filament terminal of the secondary being connected to the plate of the tube (or the aerial). The "Class B" (short-wave) coils are wound on 1 1/2-inch forms, with No. 28 D.C.C. (Continued on page 212)

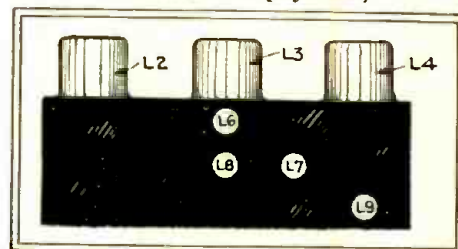

Fig. 2

Above, one of the shield cans, showing the relative positions of a group of the long-wave and short-wave R.F. tuning coils. The tuning condenser for the latter is on the shaft of C1; and a knob controls regeneration.

# A Public-Address Adapter Unit

*Constructional details of equipment which is extremely useful, in connection with the audio channel and reproducer of a regular broadcast receiver, to amplify speech to auditorium or outdoor volume*

By HOWARD SMITH\*

**T**HE practical radio man is now enabled to turn into money the use of a microphone and a standard audio amplifier for use in public-address systems. The cost, formerly almost prohibitive, has been reduced to a low level by careful design, and present prices for the equipment specified.

Theatres, dance halls, cabarets and restaurants throughout New York City have been quick to grasp the opportunity for publicity afforded by external location loud speakers coupled through amplifiers to sound pick-ups inside.

Some of the other fields that remain to be exploited by the progressive radio mechanic are auction houses and amusement park concessionaires. Traveling autos attract attention by phonograph music, a line or so of advertising between numbers.

By using a microphone with a suitable amplifier (of over one watt output rating usually) and a good dynamic speaker unit with an exponential horn, this apparatus can now be sold for about one hundred dollars, with a fair margin of profit. The writer looks for a boom in this division of radio construction.

### Economical Design

There are several convenient ways of connecting the microphone to the amplifier or radio set. One of the most successful units, the "Model 15" shown in Figs. A and B, uses a type '99 tube at V1, with 45 volts "B" potential, to feed into the primary of any standard A.F. amplifier. (The schematic

circuit is Fig. 1.) This really adds another stage of audio to the present amplifier which is available in a modern radio set.

The use of dry cells eliminates heavy and expensive A.C. equipment. The '99 requires only 60 milliamperes, intermittently; the microphone M and the potentiometer R1 consume only about 15 to 20 ma. These requirements are easily met by dry cells; the average working capacity of which is about twenty-five thousand milliamperere hours, or the equivalent of about three hundred hours of intermittent use. The small "B" units

changing type of adapter). For instance, the plate voltage of the first tube in the power amplifier may be applied to V1 by changing the leads of the plug D from the binding posts P and "B+ 45," to P and C; therefore, no specific connection is shown.

The potentiometer R1 controls the voltage applied to the microphone M; unnecessary consumption of current by this resistor and the microphone is prevented by the off-on switch Sw1, which is ganged to R1. Switch Sw2 is the off-on unit for V1, and the high-resistance potentiometer R2 is the volume

Fig. 1

The diagram at the right is that of the public-address adapter unit illustrated at the lower left and lower right of the page; its principal elements are a good microphone, a high-class audio transformer and a single dry-cell tube with its power supply. The assembly is designed to work into a power amplifier, which may be that of a modern radio receiver, or an independent unit. With this adapter and amplifier, speech may be broadcast with excellent quality.

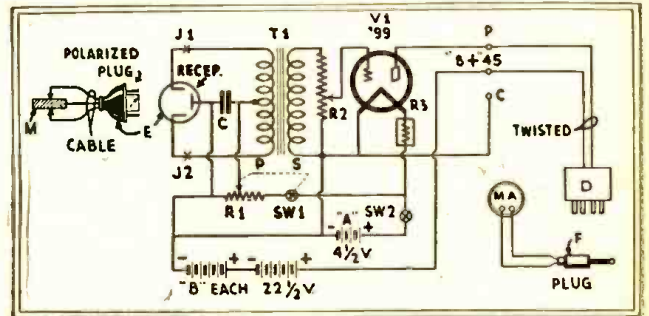

selected are adequate for the 1-ma. plate supply.

These adapters will work into either A.C. or battery-operated amplifiers; and, where there is a difference in the input requirements, the adapter-plug D may be wired to suit (or connected through a circuit-

control for the adapter. It will be noted that good parts are used in these public-address adapters; this is a fundamental requirement for satisfactory results.

The use of V1 is recommended to insure sufficient volume from the microphone output. However, if the installer does not care

\* Technical Director, Radio Construction Laboratories.

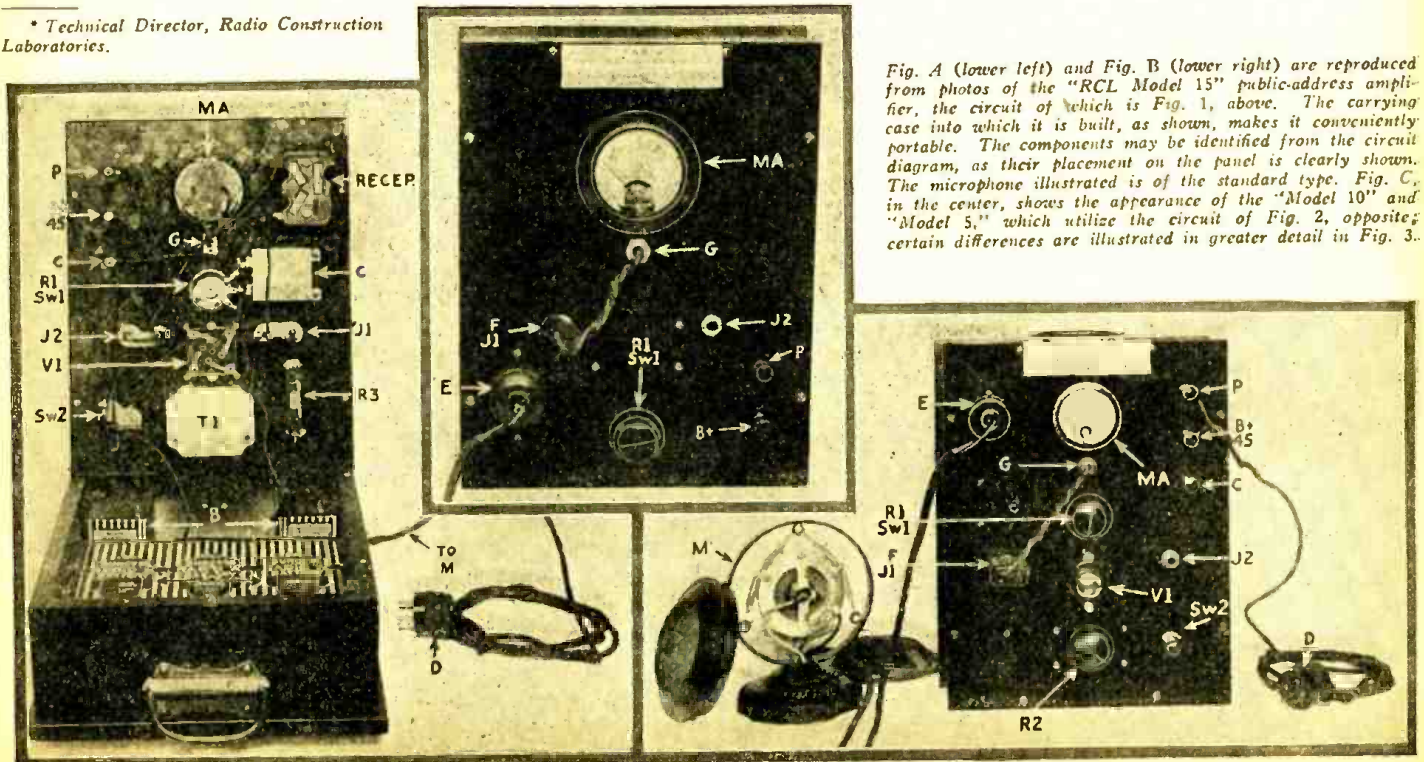

Fig. A (lower left) and Fig. B (lower right) are reproduced from photos of the "RCL Model 15" public-address amplifier, the circuit of which is Fig. 1, above. The carrying case into which it is built, as shown, makes it conveniently portable. The components may be identified from the circuit diagram, as their placement on the panel is clearly shown. The microphone illustrated is of the standard type. Fig. C, in the center, shows the appearance of the "Model 10" and "Model 5," which utilize the circuit of Fig. 2, opposite; certain differences are illustrated in greater detail in Fig. 3.

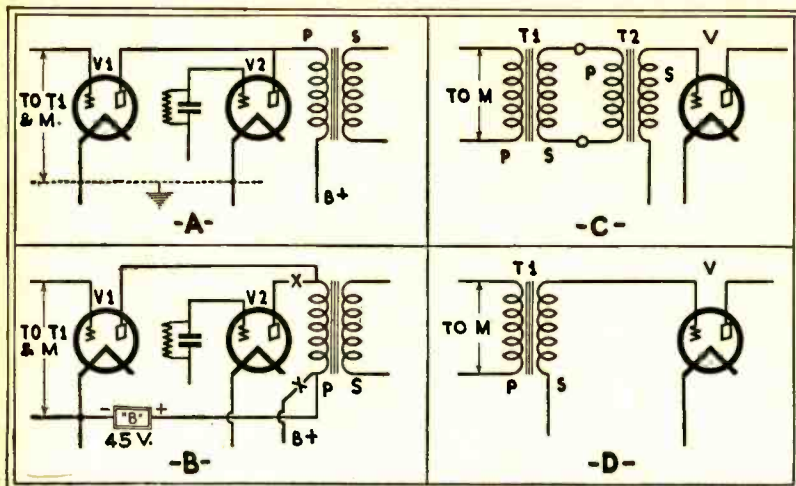

Fig. 3

Four principal circuit variations of the public-address adapter: (A) the '99 amplifier tube V1 here obtains its "B" supply from the power amplifier; (B) these are the connections shown in Fig. 1; (C) the detail of Fig. 2; (D) the circuit used to couple the microphone directly into the power amplifier. Each microphone primary is center-tapped, as in Fig. 1.

to use a tube before his amplifier, there remain at least two other methods of connecting a microphone to a standard A.F. amplifier.

Other Designs for the Adapter

In Fig. C is shown the exterior of a "Model 5" adapter built in accordance with Fig. 2; the microphone now feeds directly into the A.F. transformer T1.

It may be well to clarify this question of coupling by pointing out that, in Fig. 3, A and B represent the methods previously described. At C there is shown a radical change in design; for T1 is now an "equalizing" transformer (Amertran "type 629") with a primary of 100 ohms resistance on each side of the center tap to match M, and a secondary of 120,000 ohms impedance to match the primary winding of a standard "DeLuxe" first-stage A.F. transformer T2. Tube V is the first audio stage in the external amplifier. This circuit is used where it is not desired to make any change in existing equipment.

However, somewhat greater volume is obtained by coupling the microphone output directly into the external amplifier. The connections are then as indicated at D; and T1 is then a "Type 629" unit. This design constitutes the "Model 10" adapter. This circuit is used when coupling to a Loftin-White amplifier; it then becomes necessary to shunt the secondary of T1 with a variable resistor R4 (shown in dotted lines in Fig. 2). This unit, which should have a maximum value of about 500,000 ohms, is used to prevent audio oscillation. An "L-W" amplifier using type '45 output, two Jensen "Concert" reproducers and the "Model 10" adapter are capable of filling a 400-capacity dance floor. (A standard three-stage transformer-coupled amplifier using type '50 tubes in push-pull, and suitable reproducers, will flood an average theatre.)

Taking Care of "Mike"

One thing to remember is that, to prevent howling, the microphone must be shielded by distance, placement, or mounting, from the sound waves emitted by the speaker.

Two closed-circuit jacks have been provided for checking the current applied to each button of the microphone. The procedure is to adjust the current of one button to a value of about five mils.; then plug MA into the other jack. Here the current may be ten mils.—the maximum that should be applied. We are thus able to keep the granules from burning; replacing them is a difficult job.

Diferent readings for the two buttons will often be found; since moving the microphone will disturb the balance. This condition, within the limits mentioned above, is not objectionable, since the instrument will right itself.

Practical Installation Data

The most difficult job is an outdoor installation. For instance, without the use of special reproducers, it is impossible to hear a complete army brass band 200 feet away, with a strong wind blowing.

One of the hardest places to obtain good volume is along an ocean front where there is a strong wind blowing, and no side walls to hold the sound. In such cases, it is advisable to place the reproducers at various corners of the area to be covered; so that, regardless of which way the wind is blowing, part of the sound will be carried toward a focal point.

One of the largest installation jobs done by independent concerns in New York City is the band concert broadcasts to all the Municipal parks; and the municipal airports. One of the first appearances of public-address work was the equipment used to amuse the crowds waiting at Lakewood for the first arrival of the *Graf Zeppelin*, and the following announcements by Floyd Gibbons.

To many men who have been occupied in custom building, this work gives the chance to make a better living than if they were lost in some large radio factory. It affords them an opportunity to capitalize their sales and constructive ability; and, by eliminating factory routine, it prevents the constructor from losing his individuality.

The "Models 10" and "5" adapters include the same parts, except where otherwise noted, as the "Model 15" unit. "RCL Model 15 Public-Address Adapter" is pictured in Figs. A and B, and shown in diagram form in Fig. 1.

List of Parts

- Two Yaxley "No. 702 Junior" closed-circuit jacks (J1, J2);
- One Stromberg-Carlson "No. 15" phone plug. (F);
- One Universal "Model KK" double-button microphone, with stand and 12-ft. cable (M);
- One Amertran "No. 923" microphone transformer: (pri., 100 ohms each side of center tap; sec., 6,000 ohms) (T1);
- One Electrad potentiometer, 400 ohms, with switch (R1);
- One Electrad "Royalty Type E" resistor, 500,000 ohms (R2);
- One Amperite "No. '4V-99" (R3);
- One type-99 vacuum tube (V1);
- One Yaxley "Midget" filament switch (Sw2);
- One Weston "Model 506" milliammeter, 0-15 ma. (MA);
- One Flechtheim 2-mf. by-pass condenser (C);
- One tube base, 4- or 5-prong, with 4-ft. twisted pair lead (D);
- One Hubbell plug and receptacle, polarized (E);
- Two Burgess "No. 4156," 22½-volt "B" blocks ("B");
- Three Burgess "No. 6" dry cells ("A");
- One bakelite panel, 12 x 9½ x ¼-in. thick;
- One cabinet (inside depth, 3½-in.);
- Miscellaneous hardware (with bushing G).

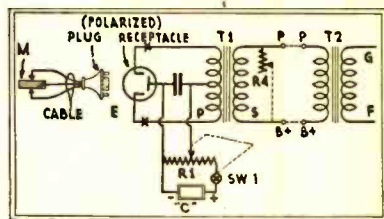

Fig. 2

A universal circuit, for moderate volume. By connecting T2 to a switching system it may be cut into the circuit to adapt the unit to various input conditions. Plugging a 0-15-ma. meter into the circuit at X may prevent burning up the double-button microphone M.

A RADIO SHERLOCK

AN old story is thus told with an amusing twist in the pages of *Popular Wireless*, London:

"A man who had made up a set with too little regard to the suitability of the bits and pieces was horrified to hear an orchestra playing with five members absent: to wit, the flutist, the clarionetist, the 'cellist, the bass viol, and the drummer. He thought that either he or the station director had gone crazy.

"Eventually a radio detective found the remains of the drummer in the loud speaker, and the clarionetist in the power tube. The 'cellist was found wandering between two tubes, one having kicked him out and the other having refused to take him in. The bass viol was found hanged in a transformer winding; and the flutist had been mistaken for a violinist."

# RADIO CRAFT KINKS

*Constructors and experimenters are invited to send in all original and ingenious ideas which they have hit upon in their work; "Kinks" are paid for at regular space rates. Make your descriptions as clear as possible; preferably by sketches, to guide our staff artists.*

## A CONTINUITY TESTER AND A COIL-WINDING KINK

By H. Pack

THE continuity tester shown in Fig. 1 contains absolutely nothing new in principle; but its compactness gives it a degree of convenience that will amply reward the constructor.

Take a small flashlight and remove the bulb to make room for the center binding post, which must be carefully insulated from the metal case with a couple of fiber washers. A single telephone of the watchcase type is then connected to the post by one tip while the other is utilized as a test prod. The second test prod is readily obtained by the use of a stiff piece of wire, which clips into a holder in the case when not in use. This prod, of course, is connected to a binding post which makes good contact with the metal case and through it with the batteries.

Little comment also is required concerning the adaptation of a phonograph motor as a coil winder, by means of the rig illustrated in Fig. 2. A drill chuck is mounted on the shaft of the motor as shown; if necessary, a fiber or metal bushing may be used to fit the shaft to the chuck.

## ADJUSTABLE DETECTOR MOUNTING

By G. B. Ashton

AS an experimenter with Interflex hook-ups, I found it desirable to convert my fixed Carborundum detectors into the semi-adjustable type. This was readily done in the manner illustrated in Fig. 3.

The business end of the detector assembly—that containing the crystal—is that marked

"G"; the metal collar of the assembly is removed by pulling out the pin which locks it, and the wire connecting the crystal to the metal is broken.

The angle irons used for mounting were purchased in a "5 and 10," and their ends cut off to bring them to the required size. After the assembly has been made, as shown, the crystal is adjusted by bringing the proper pressure to bear on it with the screw. When the best operating condition is found, the lock nut is tightened; and the adjustment will serve for a long time.

## CHOICE OF RECTIFIERS

By Edward J. Arnold

HAVING use in the shop for a power-supply unit capable of using either an '80 or a "BH" gaseous rectifier tube, the writer evolved the circuit shown in Fig. 5. It may be of interest to others who can utilize the idea.

The sockets should be labeled plainly; as it will be exceedingly deleterious to an '80 tube to insert it in the socket intended for the Raytheon.

## A HANDY CONTROL-GRID CAP

By C. W. McKee

THE writer has made the discovery that an "1/8-in. cap" has a threaded top which makes a good contact with the top or control-grid connection of a screen-grid tube. This cap is the top portion of an electric lamp socket designed to thread upon a pipe; such are obtainable apart from the shell of the socket at any electrical supply store. In Fig. 4 an illustration is given of the manner

in which the desired threaded portion (ferule) of the cap is obtained—by sawing it from the lower part of the cap.

Solder the lead to the brass ring and use the set-screw in the cap-ring to improve the contact to the tube cap.

## IMPROVISING A CHOKE

By Yee You

OTHER readers of RADIO-CRAFT may be interested in the manner of making a simple R.F. choke shown in Fig. 6.

A rod, of wood or, preferably, bakelite, 3 inches long, is wound with No. 32 D.S.C. wire to the total of 170 turns, covering two inches of its length. Anchor the ends of the wire through holes drilled in the half-inch spaces left at the ends of the rods.

Any convenient method may be used to mount the finished coil; the writer prefers to drill two additional holes and run two long 6/32 machine screws through these holes into the chassis of the receiver.

## A RADIO SET WITHOUT COST!

By Rev. Arthur Forest Wells

EXPERIMENTERS who will try anything once may find some interest in duplicating the experiment performed by the writer, at a moment's notice, in demonstrating to his son, aged eleven, the simplicity of fundamental set design. He had exhibited a one-tube and a crystal set; and the idea came to him to demonstrate the quality of a poor detector, as a contrast with the advantages possessed by modern radio experimenters. The operation was aided by

*(Continued on page 243)*

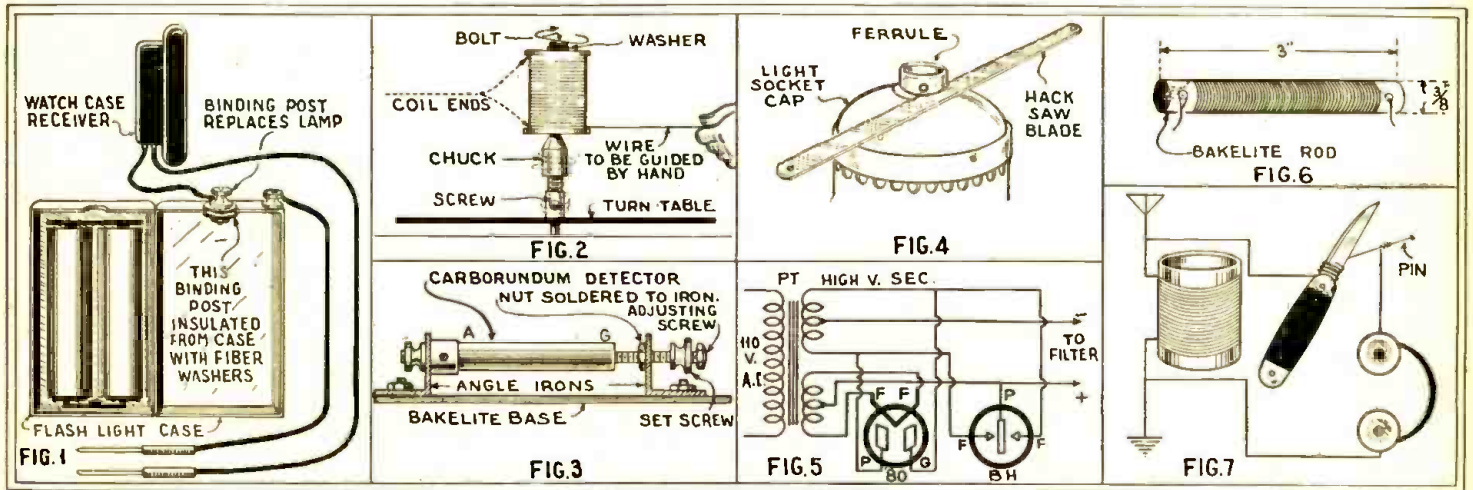

The kink at the extreme left is an ingenious mechanical arrangement of a head-telephone continuity tester, reduced to pocket size. A small flashlight unit provides the batteries, and a single small phone is sufficient for the purpose. The same Kinkrafter also shows originality in using a phonograph motor for a coil winder, as shown in Fig. 2.

In Fig. 3, a fixed Carborundum detector altered to the more sensitive adjustable type. The electric-lamp socket of Fig. 4 is converted quickly into a screen-grid

cap, leaving a brass shell for which a later kink will no doubt find a use. The hook-up of Fig. 5 enables either a filament-type or cold-cathode tube to be inserted into a rectifier circuit; with the latter, however, two 0.1-mf. buffer condensers are desirable. The unit of Fig. 6 provides an R.F. choke quickly.

In Fig. 7, we seem to have the irreducible minimum for a homemade radio receiver; it is not warranted to bring in any distant station, and must tune itself rather close to a local's wavelength.

# A Powerful Two-Volt Screen-Grid Receiver

The new dry-cell tubes, which have been designed for very low current consumption, lend themselves admirably to portables.

The circuit shown has been designed for this special purpose.

By H. G. CISIN

THE recent development of two-volt tubes, in three desirable types, makes it possible to build a receiver obtaining its "A" current from two dry cells, and therefore lighter and more compact in its power supply than anything previously available; while the reduced current drain makes such a set more economical, as well as efficient, in operation.

of a wooden carrying case, 15 inches wide and 16 7/8 inches high, the bottom of which holds the magnetic cone speaker and the batteries (3 volts of "A," 1.35 of "B" and 22.5 of "C"). A front cover, with sides one inch deep, carries a box loop; since the case rests upon four small rubber feet, the loop may be swung to the position giving the greatest signal strength. In addition, a

knob, and the antenna jack. In the lower portion of the panel, the circle cut out for a speaker opening is covered with wire or silken screen. The rear cover of the case is hinged to give ready access to set, speaker and batteries. Convenience in carrying is obtained by the provision of a strap at the top; and a leather covering will give the completed job an enhanced appearance.

The aluminum chassis serves as a common "A—" and "B—" return and ground; good strong connections are essential here, and at all joints, since a portable receiver must stand the strain of much moving about. The metal is cut out in the center at the front to accommodate the drum dial, which is coupled to the shafts of the two two-gang condensers and thus gives single control. Holes must also be drilled at the rear for the five sockets which are mounted in a row from beneath the deck, with two fastenings each. The A.F. choke is secured underneath, to the rear wall, with its terminals toward the deck. The shielded R.F. coils are arranged in a row beneath the center of the deck, with their terminals lowest. The bypass condensers and filament resistors are also mounted below deck; the potentiometer-switch on the vertical center line of the front wall, about 1 1/4 inches from the bottom. The R.F. choke is located on the underside of the deck, near the detector socket.

On the upper side, the condensers are turned to use one side as a base, to conserve space; their plates face the rear. Their frames are insulated from the deck with small washers; and they are secured with small angle brackets. Their trimmers are located in recesses which are now presented uppermost. The drum dial is coupled between their shafts, but not fastened to the chassis. The screen-grid leads for the '32s are soldered to the stators. Carrying all

(Continued on page 241)

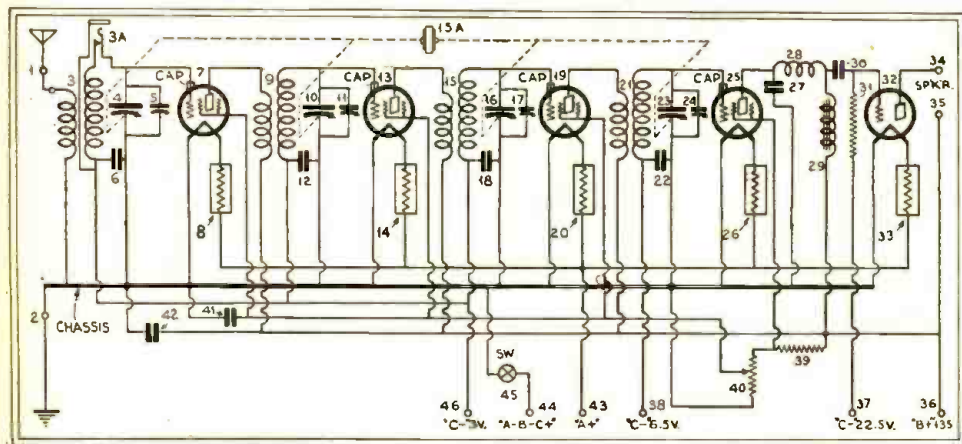

Fig. 1

The five tubes shown give high R.F. amplification and power detection, with suitable volume for ordinary use. The receiver is economical to operate, and may be used with either loop or regular antenna, as conditions may dictate.

The circuit shown here uses four of the new '32 type screen-grid tubes as three R.F. stages and a power detector; the last feeds into a '31-type power tube, which is rated at 170 milliwatts, undistorted. The R.F. stages, because of the desirable characteristics of the new tubes, give even higher amplification than the previous D.C. and A.C. screen-grid tubes made possible. The screen-grid detector, operated with a control-grid bias of 6 1/2 volts, delivers to the power tube a signal of such strength that no intermediate A.F. stage is necessary. No grid leak and condenser are required. As for volume control, a very effective one is obtained by the use of a potentiometer, which will put on the screen-grids of the three R.F. tubes any desired positive potential from zero up to a maximum of about 75 volts. The constancy of filament voltage, a necessary operating detail, is maintained automatically during the life of the "A" batteries.

### Construction of the Set

While this circuit may be built into a receiver of almost any desired form, it lends itself most admirably to the design of a portable set. During the past few months the portable has had a steady accession of popularity, due to its obvious advantages. It may be used in the automobile whenever desired, transferred to the bungalow or the motor boat, taken to the beach or the canoe—or, in short, picked up and carried wherever its entertainment is desired.

The "Powerful" screen-grid portable set designed by the writer was constructed on an aluminum chassis, to which its parts were mounted, and then built into the upper part

jack (3A in the diagram) permits the use of a regular aerial and ground.

The chassis, an aluminum pan 6 x 14 inches and 3 inches high, is made from a sheet of 14-gauge metal 12 x 20 inches with a 3-inch square cut out at each corner; the sides are bent down squarely. In this shape, with all components mounted to its deck or sides, it is supported on a wooden shelf 8 inches below the top of the case. A three-ply panel, 15 x 16 7/8 inches, covers the assembly; through this are brought only the dial window and tuning control, the volume-control

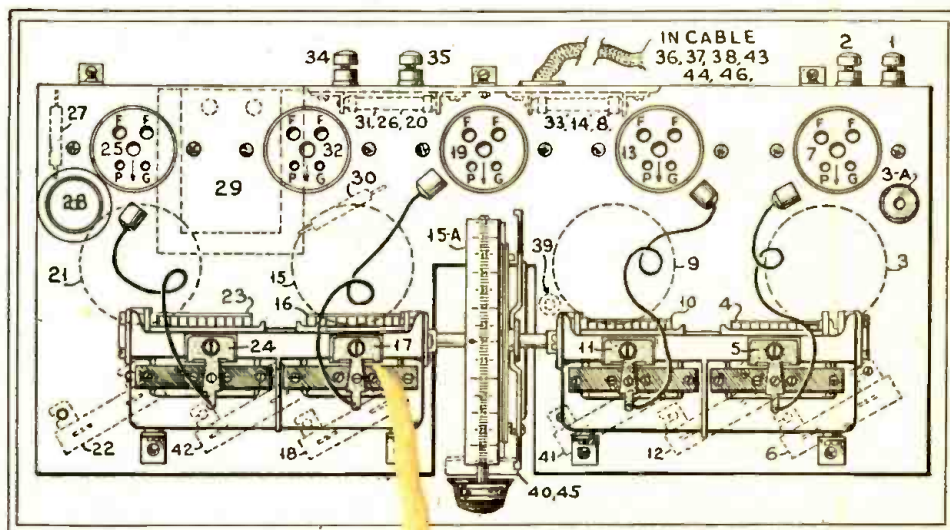

Fig. 2

The constructor will find it most advantageous to mount the receiver's components on an aluminum chassis pan, which is shown here in a plan view, from above. This chassis will mount conveniently in the top of a handy carrying case.

# Running Your Radio for "Nothing"

*How the simple expedient of putting a receiver in the return lead of a group of lights makes operation from D.C. light lines easy and inexpensive*

By ARTHUR T. BROWN

USERS of direct current have not had much attention paid to them by the makers of power-packs, "A" eliminators, and the like. The reason, of course, is that the former are in a minority—except on Manhattan Island in New York City. Then, too, direct current is such an inflexible thing! You can't take a transformer of one type and make 110-volt house current produce 6 volts; and a transformer of another type and make the house current produce four hundred volts.

And yet, we, in the "D.C." districts, have certain advantages. We can make our living room lights "produce" power for our radio receivers for "nothing," or very nearly; or, turning it around, we can make our radios light our living rooms for "nothing."

Furthermore, short-wave enthusiasts can get power from D.C. lines that will allow reception on their favorite frequencies without line-noises—something that, so far, is not practicable with A.C. lines.

The power plant described in this article allows the writer to get light for his living room and "A" power for his receiver for the cost of either—the only addition to the light bill, for the radio, being the 5 watts consumed in the form of plate current—an amount so small that it totals literally only a few cents a year. And the device to be described allows the reception of short-wave stations with freedom from man-made "static" as great as by the use of batteries.

The machine is not expensive; parts can be obtained for about \$35. They can be put together ready for use in three or four hours. If one is not interested in short waves, or has a set of only average sensitivity, the cost and the time for construction can be cut down somewhat as indicated later.

### Arrangement of Units

The complete circuit is shown in Fig. 1. It comprises essentially the standard "Raytheon" circuit for the plate supply (leaving out, of course, transformer, rectifier, and buffer condensers), and a two-choke, two-

condenser filter for the "A" supply, using "Mazdas" as the resistance to cut the 110 (actually usually 120-130) volts down to the six required for storage or dry battery tubes.

This circuit yields 90 to 100 volts of amplifier plate potential; from 30 to 100 volts for the detector; six volts for filaments (or four, or even two volts, depending on the lamps used for resistances); and, if desired, four or five volts for "C" potential. If one uses a single power tube in the last stage, additional plate potential will be needed, and can economically be secured from the largest dry "B" batteries; since only a part of the current required by a single tube need be supplied by them. In that case, additional grid bias is needed, and is best secured by dry batteries, also; because every volt that is taken for grid bias is deducted from that available for plate use. And, of course, "C" batteries have, so used, a life equal to their "shelf-life"—about a year.

With certain types of sets, those in which all tubes are negatively biased, the use of grid bias from the line can be made to help in eliminating line-noises, and hence the method of securing such bias is shown here.

One can, of course, get satisfactory loud-speaker volume and quality without the use of plate batteries by using four or more (an even number) power tubes in a last push-pull stage of audio, paralleling two or more tubes in each leg of the push-pull stage. Even in this case, however, more than the suggested four or five volts of grid bias will be needed, and should be supplied by dry batteries.

Let us look, now, at the circuit in somewhat more detail.

### Fuse Properly

Starting at the D.C. input shown at the left (Fig. 1), the first elements we encounter are two three-ampere fuses—one in each side of the line. One is usually sufficient, but because of the fact that there are three potential levels ("A—B—"; "A+"; "B+")

a short in the pack might ruin some of the apparatus before blowing the fuse, were there only one; whereas with two, the current, seeking the shortest path, is twice as likely to blow a fuse rather than apparatus. The writer speaks from experience in advising a fuse in each side of the line!

The next element in the circuit is the double switching arrangement (S1, S2) by which one may have lights without radio (S1), or lights with radio (S2). It should be noted that no harm is done if both switches happen to be on at the same time; the lights will take all the current.

Immediately following the switches is a 4-mf. condenser (450-volt rating) C8, which is put across the D.C. line, and serves to remove the last vestige of commutator ripple from the pack. C8 is very important, especially for short-wave reception. Using phones in the output of a seven-tube shielded superheterodyne, no ripple or other line-noise is audible—when there is no pick-up device, loop or antenna—from six hundred down to twenty meters. Without C8, however, commutator ripple is audible enough to be annoying on phones, though it is hardly noticeable on a speaker.

Following C8, the circuit divides into three parts, those for plate, for filament, and for grid supply.

### The "B" Section

The plate supply is standard—two thirty henry, 85-mil. chokes with condensers of 2-, 2-, and 8-mf capacity. (L3, L4, C3, C4, C5 respectively). The detector tap is bypassed, as usual, with a 1-mf. condenser (C6). R1 is an adjustable resistor of 5000 ohms; and R2 a semi-fixed resistor of 8000 ohms, adjusted, in the writer's pack, to approximately 4000 ohms. The amount of resistance required in R2 will depend on the demand made by the tubes connected to it, and on the voltage range desired.

No provision has been made for an intermediate voltage between the detector value and the full output, since most receivers can use 90-100 volts on all amplifier tubes except the last stage of audio.

### Figuring the Wattage

Coming, now, to the filament supply, we find a somewhat less conventional and more complicated construction. To get a lower voltage from D.C. lines, a resistance must be used. It must be capable, not only of cutting the voltage down to that required, but also of passing safely the current required. That used here (See Resistance Table) to produce a suitable filament supply from D.C. house current will most economically consist of ordinary "Mazdas" of a wattage sufficient to pass the current required. Several lamps in parallel may be used, so long as the total wattage is right. For example, the writer uses seven  
(Continued on page 243)

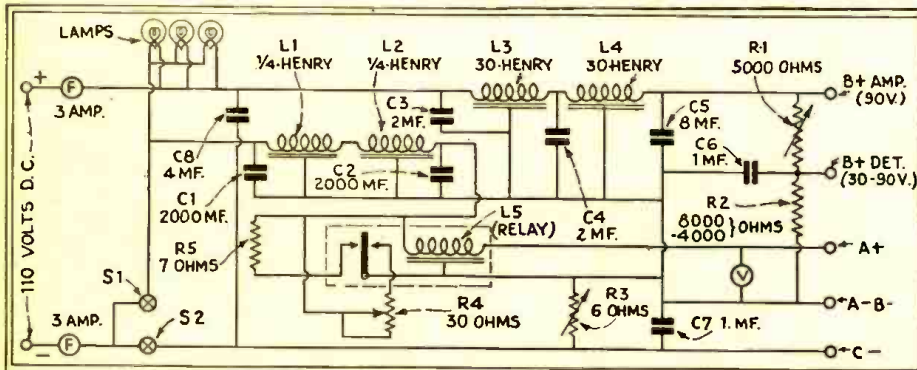

Fig. 1

The circuit of Mr. Brown's D.C. power-supply unit. The "B" current flows through the filter chokes L3-L4 to the voltage divider; the resistor R3 gives "C" bias, if it is desired to do without batteries here. The filament current passes through the lamps; the wattage of which is determined by the requirements of the set, in accordance with the table in this article.



# New Radio Devices for Shop and Home

In this department are reviewed commercial products of most recent interest. Manufacturers are requested to submit descriptions of forthcoming developments.

## THE "VARIOTONE" AND "EAR PHONE ADAPTER"

TWO products of Insuline Corporation of America, New York City, the "Variotone" and the "Ear Phone Adapter," accessories to the radio receiver, make their bid for public attention this season.

The "Variotone" offers to the owner of present radio sets the "tone control" feature



Fig. A

The universal tendency in new receiver models is toward tone controls to suit quality to the individual operator's tastes. This device applies the same improvement to an older receiver.

which is an integral part of the latest models, designed for the coming season.

The circuit comprises two 0.1-mf. condensers in series, the center tap being one output connection. The two separate condenser leads connect to the two ends of a 100,000-ohm potentiometer; one directly, the other through an 85-mh. choke coil. The arm of the potentiometer is the other output connection. The two output leads of this instrument may be connected to the two plates of a push-pull output tube system; or to plate and ground, for the ordinary single-tube power amplifier. The center position of the potentiometer arm gives normal reception; turning it toward the single fixed

## Dollars For Ideas

**B**EGINNING with the next issue, we will pay \$1.00 for every idea submitted along the following lines.

Every one of us frequently finds fault with radio manufacturers because they overlook the obvious. Whether we are radio Service Men or plain set owners, we often are wrathful because the manufacturer obviously did not think.

The dollar ideas which we are going to pay should be along the lines of—  
**HINTS TO RADIO MANUFACTURERS**

Here is a sample:  
Frequently it is necessary to install one or more loud speakers to be connected to the set, in order to have the music transmitted to other parts of the house or apartment.

With present-day sets, this is almost impossible without cutting into the wires leading to the loud speaker. No effort has been made by the manufacturer of the sets to provide extra terminals to hook up additional external loud speakers; though it would cost only a fraction of a cent to do so. At the present time, the lack of this facility exasperates the radio owner as well as the Service Man.

condenser results in emphasis of the bass notes, while the treble notes are emphasized when the arm is turned toward the end to which are connected the R.F. choke and fixed condenser in series. A turn of the knob to

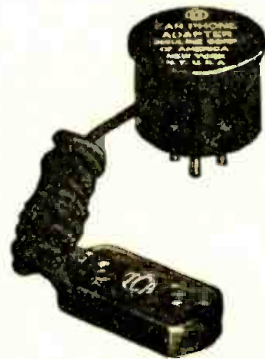

Fig. B

Service Men find that many set owners are still interested in DX work, and often remodel sets to permit headphone use. This little adapter requires only to be placed in an A.F. tube socket. Its uses, too, for service work are many.

the opposite end of the potentiometer causes the low notes to be by-passed, or lost out of the reproduction; and more understandable speech results.

There are, of course, numerous other times when tone control is desirable.

The "Ear Phone Adapter" is to be plugged into an audio stage socket in place of the tube. Headphones are then plugged into the connector provided for the cord-tips, and thus connected from grid to filament; or, in effect, in shunt to the secondary of the A.F. transformer.

Numerous instances where it is desirable to have the convenience of headphone reception will occur to the Service Man. In the first place, more distant stations may be heard. This single feature should enable the Service Man to find ready sale for such an accessory. In addition, the Service Man should find this instrument useful for isolating circuits under test.

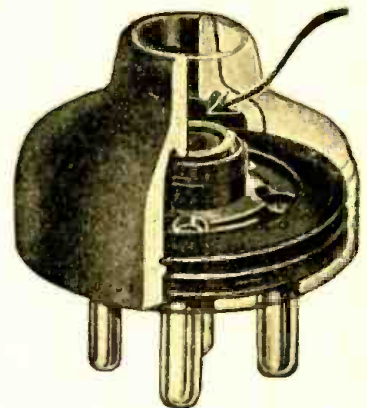

Fig. C

The cable plug shown above was expressly devised to connect a dynamic speaker to a set; but may be used for many other purposes. It is obtainable for UX and UY sockets.

## ALDEN CABLE PLUG

THE convenience afforded by the use of an ordinary tube socket, as a means of connecting a dynamic reproducer to a radio  
(Continued on page 247)

# Review of Recent Radio Literature

**R. D. A. DEALERS' BLUE BOOK.** (First Edition.) (Available to members of the Radio Dealers' Association of America.) Leather-grained limp, blue cloth loose-leaf folder; approximately 100 leaves of heavy white paper and seven bristol-board index inserts. Size 10 by 11½ in., 1½ in. thick. Includes also "Trouble Shooter's Manual" (reviewed in the October, 1929, issue of RADIO-CRAFT) and the "Supplementary Diagram Package No. 1," (reviewed in the June, 1930, issue of RADIO-CRAFT), both by John F. Rider. The loose-leaf folder is divided into the following sections: Appraisals; Reproducers; Automatic and Portable Phonographs; Electric Pick-ups, Motors and Turntables; Tube Specifications; Furniture Specifications; Trade Directory. (As part of a service to its members, the Radio

Dealers' Association of America, Inc., New York City, has prepared the above described reference material, for the use of its members, on a loan basis; that is, the publications of Mr. Rider remain the property of the subscriber, but the loose-leaf Blue Book must be returned to the R. D. A. upon the expiration of the membership.) The section headed "Appraisals" gives the model name and number, type of set (electric or battery), number and type of tubes used, power consumption, list prices in the East and the West, the "appraisal" value (by which the dealer is to gauge his "allowance" price), general description (table or console), type of speaker; and it answers the question whether the set is ordinarily sold with or without tubes. It covers 65 standard makes of radio sets. The section on reproducers gives similar information on the types, cost, and construction of the reproducers made by 29 manufacturers. Automatic phonographs, portable phonographs, electric pick-ups, phonograph motors and turntables, tubes, and radio furniture are described in similar detail.

The last section of the book is a valuable trade directory in which hundreds of makers of sets and parts are listed (with their addresses); sixteen pages are required for this listing. This excellent compilation should be of exceptional value to every dealer organization. (R. D. W.)

**RADIO AND ITS FUTURE**, edited by Martin Codel. (First Edition, with foreword by Senator Guglielmo Marconi.) Cloth, 6 by 8½ in. 350 pages. Illustrated with five plates. Harper and Bros., New York City. Price, \$4.00. For a number of reasons, *Radio and Its Future* should be in the hands of everyone interested in radio. Throughout the entire text runs a vein of optimism for the future of every branch of radio. (Continued on page 249)



**SPECIAL NOTICE TO CORRESPONDENTS:** Ask as many questions as you like, but please observe these rules:

Furnish sufficient information, and draw a careful diagram when needed, to explain your meaning; use only one side of the paper. List each question. Those questions which are found to represent the greatest general interest will be published here, to the extent that space permits. At least five weeks must elapse between the receipt of a question and the appearance of its answer here. Inquiries can be answered by mail only when accompanied by 25 cents (stamps) for each separate question. Other inquiries should be marked "For Publication," to avoid misunderstanding. Replies, magazines, etc., cannot be sent C. O. D.

**PRIESS "NINE-IN-LINE" RECEIVER**

(89) Mr. J. A. Kohling, Marion, Kan.  
 (Q.) A Priess "Nine-in-Line" radio set recently has come into our shop for repair. However, we cannot determine the values of some of the parts needing replacement. What are the electrical values used in this old radio set?

(A.) Like certain famed birds, the circuit of this set is a rare specimen. It is printed for the first time in these columns (Fig. 89); with the observation that the wiring of the multiple-contact circuit-changing switch may be found differently connected in certain models, though the result will be the same.

The circuit herewith reproduced is that of the "Model R" (rural model); the "Model C" (city model) has one less stage of untuned R.F., one more stage of tuned R.F., and incorporates impedance-capacity audio coupling.

Test all fixed condensers for open circuit as well as short circuit. From careful consideration of this diagram, it will be evident that the suburban resident may obtain added "distance" with this receiver, by winding a few turns of wire around the loop and connecting the two ends to an aerial and ground.

Another interesting observation is that the set is adaptable to screen-grid modernizing by the clever Service Man. The tubes most conveniently replaced by '22's are V2, V3, V4 and V5. If such a change is contemplated, it will be necessary to replace the 2-ohm filament resistor by a 30-ohm rheostat, and to use a filament ballast for V1. Special care should be taken to operate the filaments of the screen-grid tubes within their rated voltage.

Another improvement worthwhile, and without not expensive, is to connect the A.F. transformers "parallel-plate-feed," as described a number of times in past issues of RADIO-CRAFT (viz: July, 1929, p. 38; August, 1929, pp. 61 and 84; September, 1929, p. 131; November, 1929, p. 237; April, 1930, p. 532; June, 1930, p. 619; September, 1930, p. 136).

**DYNAMIC REPRODUCERS—ELECTROLYTIC CONDENSERS**

(90) Mr. Harold Saeger, Quincy, Ill.  
 (Q.1) What is the cause of low-note distortion in dynamic reproducers when the high notes can be heard without distortion?

(A.1) We take this opportunity to present a few observations, by the engineers of the Kolster Radio Corp.; which, although particularly applicable to the Kolster dynamic reproducer used in the "Models K-23" and "K-24" combinations, apply to most dynamic units.

"If the leather backing is loose, the reproducer will rattle on the lower audio range." If the voice coil goes off-center, the rattling will be noted on the overtones. Most reproducers are equipped with a central "spider" which is fastened to its rim to the voice coil and at its center to the core of the pot-magnet. If this spider cracks—a not unusual occurrence—high-note distortion will usually result. This distortion will be most evident when certain single high notes are being sounded, as during a solo; when the tone will "go sour." Lack of good low-note reproduction is sometimes traced to hardening of the leather ring. This ring, in a dynamic reproducer of poor workmanship, is cut from a cheap grade of leather, and often loses its flexibility. A person with a well-trained "radio" ear can detect the distortion this causes; for extremely low notes will lack fullness, or "depth," and the harmonics of the low fundamentals will be unduly emphasized.

Distortion caused by the voice coil touching walls of the channel, in which it should ride freely, is almost always a very pronounced and loud "rattle," although an even louder rattle will result if the screw in the center of the spider should loosen.

Another source of distortion, and one usually blamed unjustly on the reproducer, is loose parts with the acousti-dynamic range of the loud speaker. In other words, little, unsuspected things like picture frames, screws in the radio cabinet, bric-a-brac on mantel or piano, two pieces of furniture which barely touch each other, a loose grille in the radio cabinet, and loose window panes, may suddenly start to vibrate audibly when their resonant frequency is sounded by the reproducer; and, the higher the pitch of this resonant frequency, the more difficult it is to localize its origin. In fact, it sometimes has taken hours to find the source of an annoying buzz which the trained Service Man would know, by past experience and listening close to the reproducer, did not originate in the loud speaker. It will be understood why this form of distortion is almost always confined to a single note or two in the audio scale.

Still another form of distortion is the annoying huzz that appears over the greater portion of the high-frequency end of the band. This fault, usually,

is due to foreign particles in the air gap between moving coil and fixed pole-piece. If the Service Man has a "lucky break," he may succeed in blowing them out; then again, he may need to "operate." The latter procedure should not be attempted on a customer's reproducer until the technician has thoroughly familiarized himself with dynamic-reproducer assembly and adjustment, by study and practice on his own experimental equipment.

A damaged cone will sound very much like the "dusty air-gap" just described. Only experience enables the Service Man to recognize its characteristic sound.

(Q.2) What are the dimensions of the coiled sheets of metal foil used in the 8-mf. Mershon electrolytic condenser and the 2,000-mf. Elkon dry "A" condenser shown as Figs. C1 and B, respectively, in the September, 1930, issue of RADIO-CRAFT, on p. 148?

(A.2) The coiled strip used in the former measures 2 in. by 36 in.; two strips are required in the latter, each one measuring 5 in. by 72 in.

**"B" POWER FROM STORAGE "A"**

(91) Mr. A. Chateau, New Orleans, La., and Mr. L. L. Sander, Los Angeles, Calif.

(Q.1) (Mr. Chateau) Is it possible to apply the idea described by L. B. Robbins ("Obtaining 'B' Power from a Storage 'A' Battery," in the July, 1930, issue of RADIO-CRAFT), to the operation of a regular 110-volt A.C. receiver, mounted in an auto truck, using three '24's, two '27's, two '45's, and an '80 tube? It is the purpose of the proposed installation to use the operating radio set as a means of attracting attention, for advertising purposes. Perhaps such a combination is now on the market.

(A.1) The answer to this question probably will interest a number of RADIO-CRAFT readers. Mr. Robbins advises: "It is perfectly possible to use the converter in a truck to operate a 110-volt receiver, provided sufficient current to handle the tubes is passed through a resistor. Having determined the current requirement of the set, a resistor may be inserted in place of the lamp to pass the required current. To my knowledge, there is no such outfit on the market; although, of course, one may soon be available. Note that it will be necessary to completely shield the ignition system of the truck, if type '24 tubes are to be used in this mobile radio."

(Q.1) (Mr. Sander) What will happen if the

(Continued on page 250)

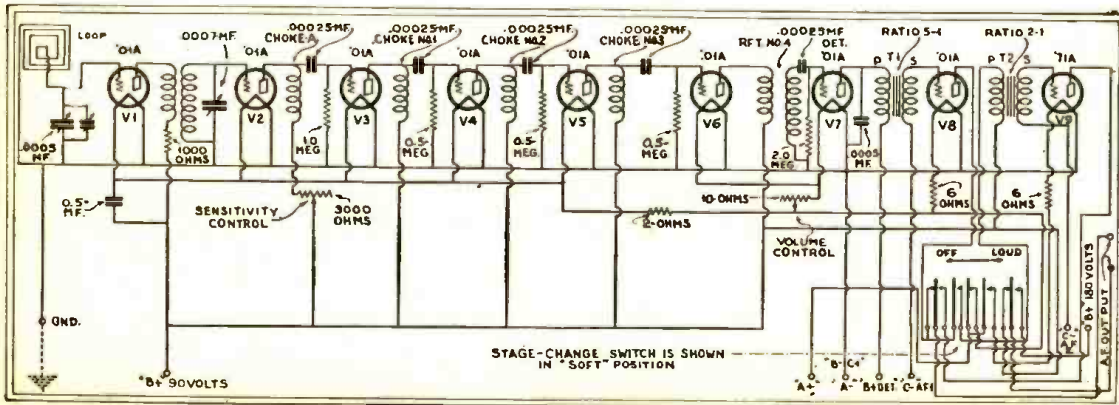

**Fig. Q.89**  
 The circuit at the left is that of the Priess "Nine-in-Line," one of the most powerful and efficient receivers of its day. This is the "Model R"; the "Model C" added another tuning circuit, to increase selectivity in congested district. Many inquiries for this circuit have been received; but it has only now become available. In some receivers, slightly different connections to the audio-stage switch will be found.



Radio Mechanic and Inspector \$1800 to \$4000 a Year

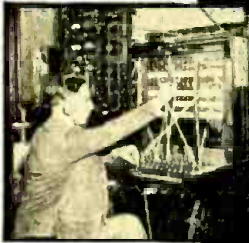

Broadcast Operator \$1800 to \$4000 a Year



Land Station Operator \$1800 to \$4000 a Year



Broadcast Station Mechanic \$1800 to \$3600 a Year

# The only course in Radio sponsored by RCA

LET THIS SHORT-CUT HELP YOU INTO

# SUCCESS *in* RADIO

**T**HOUSANDS of men are making good money at Radio—and so can you!

Commercial training is all you need to give you the professional confidence and ability. You can secure this training in your spare time . . . through a marvelous home-laboratory course sponsored by the Radio Corporation of America. Our big FREE Radio book tells all about it.

### Round out your knowledge with this home-laboratory training

Put the finishing touch to your Radio experience. Get the "How" as well as the "Why" of Radio with this commercial training. Only an hour or so a day—in spare time—is all you need. As part of your course, you receive absolutely free of extra charge—a magnificent outlay of fine apparatus. With this outfit you learn to build fine sets and solve the radio problems that bring good pay. You acquire not only the ability but the confidence to succeed in a real commercial way.

### Training backed by Radio Corporation of America

Our graduates are in demand everywhere. They enjoy greater success because they're

posted right up-to-the-minute in *everything* in Radio. Radio's progress each year is measured by the accomplishment of the great engineers at work in the research laboratories of Radio Corporation of America. This Radio organization sets the standards for the industry.

### Money back if not satisfied

The lessons prepare you for success in all phases of Radio—manufacturing, servicing, selling, ship and shore broadcasting and all types of Radio equipment. A signed agreement backed by RCA assures you of complete satisfaction upon completion of the training—or your money will be promptly refunded.

### Read this thrilling free book

It may mean the turning point in your life. It gives you the real "dope" about Radio and it describes in detail the famous training that has enabled us to place thousands of our students in fine positions, usually from 3 to 10 days after graduation! It tells in 40 fascinating pages and photos all about Radio's brilliant opportunities for adventure and success. Mail the coupon now—the book is absolutely free! RCA Institutes, Inc., 75 Varick Street, New York, N. Y.



## RCA INSTITUTES INC.

(A Division of Radio Corporation of America)

RCA INSTITUTES, Inc., Dept. SRA-10  
75 Varick Street, New York, N. Y.  
Gentlemen: Please send me your big free 40-page book which tells about the great opportunities in radio and about your famous laboratory method of radio instruction at home.

Name.....  
Address.....  
.....  
Occupation.....

# Service Men Attention!

## Add snap and style to your tool kit--

# SERVICE MAN'S BAG

No more jumbled tool kits —

No more lost tools —

Everything in its place —



THE tools of a Service Man are his means of livelihood. They are the instruments by which he brings his knowledge into play. Without them his knowledge is of little use. As important as the tools themselves is a suitable bag in which to carry them. Not only that—but a bag that offers a systematic lay-out that saves time, avoids losses and adds to the appearance of the Service Man himself.

We offer you the SERVICE MAN'S BAG that has been especially designed for him. It is roomy, serviceable, snappy and inexpensive. It is compact in appearance, yet has sufficient room to accommodate an entire kit of tools, meters, books, service manuals, blueprints, etc., with ease.

Bag is made of a heavy grade, black cowhide leather and is 16½ inches in length, 6 inches wide and 11 inches high. Illustration shows the comparative size of bag and tools. The interior of the bag is divided into five compartments. Three of these run the entire length of the bag and the other is divided in the center making two compartments. Two of these compartments are 1 inch in width and a third is suitable for papers, diagrams and data sheets. The remaining compartment is 3½ inches in width and is fitted with a removable strip of double thick leather with adjustable strap. Strap is 7½ inches wide and 18 inches in length and can be adjusted to accommodate seven different tools. The strap makes it impossible for the tools to become lost or misplaced. The sides and bottom of the bag are reinforced with an extra thickness of leather. Leather side flaps close over the top and snap into place completely closing the interior of the bag.

On the front of the bag is a pocket 8 inches long and 5 inches high, with V-shaped sides and suitable to hold service books, blueprints, business cards, etc. When the bag is closed this pocket is completely covered. Handle is set of double straps that run completely around the bag and form two handles as on a suitcase or briefcase. It is fitted with protecting cover that snaps in place and forms a hand rest. Also holds the two handles together. Bag is fitted with lock and key, adjustable to three positions depending on the contents of the bag. Five metal sliders are on the bottom of the bag so that it will not rest on the ground or mar the furniture upon which it may be set. When bag is completely closed no tools or papers can be lost from it. You may turn it on end, upside down or whichever way you desire but nothing can fall out.

The SERVICE MAN'S BAG will make your calls more efficient—save you time and trouble and will prove its worth within a short time. Fill out and mail the coupon today—we'll do the rest.



**SERVICE  
MAN'S  
BAG**

**\$ 14<sup>00</sup>**

*(Tools not included)*

**DO NOT SEND ANY MONEY**

*Fill Out Coupon—Mail Today*

GREN PARK TOOL COMPANY, RC-10  
245 Greenwich Street,  
New York, N. Y.

Gentlemen:  
Please send me your new SERVICE MAN'S  
TOOL BAG. I will pay express company \$14.00  
plus the small amount for shipping charges after  
I have received the tool bag.

Name .....

Address .....

City..... State.....

Designed and manufactured for the  
Radio Service Man. Has plenty of  
room for an entire kit of tools. Places  
tools at your finger tips. Price is rea-  
sonable.

**GREN PARK TOOL COMPANY**  
**245 Greenwich Street . . . . . New York, N. Y.**

# What The Service Man Should Know

(Continued from page 200)

where higher mathematics is involved in radio repair work, and we are heartily in accord with the man who states that it is unnecessary to be familiar with trigonometry, quadratic equations or integral calculus, to be able to repair a radio receiver.

It is, however, impossible to dismiss all calculation simply because higher mathematics is not required. We can dismiss mathematics; but arithmetic as we understand it (meaning simple addition, subtraction, multiplication, ratio, squaring, and square root) is found in every-day life. Perhaps the need for such simple forms of computation does not appear necessary upon the surface; but the full interpretation of Ohm's law involves each form of arithmetic mentioned above. Who can deny that the practicing Service Man must be familiar with the various forms of Ohm's law? Many men are familiar with the three general equations for resistance, voltage and current in D.C. circuits, but fall short when these equations must be applied.

Mathematics in radio is not essential to the comprehension of the subject. It is possible to state all laws in words; but solution of any problem entails computation and this necessitates a knowledge of simple arithmetic. While we advise a study of theory, we take this occasion to state that a thorough study of the principles underlying radio communication is not necessary in order to repair a receiver in the proper manner. We do, however, say that certain principles must be known: the practicing Service Man must be familiar with the law of series and parallel resistances; he must be familiar with the law pertaining to voltage drop in series and parallel D.C. circuits. It is of course possible to memorize these laws; but their application is impossible unless the individual is familiar with each of the above mentioned forms of arithmetic.

Squaring and square root are found in the simplest of radio problems—the determination of the permissible current through a resistance rated at a certain value in ohms and a certain value in watts dissipation. Ratio or percentage is necessary when solving for the voltage drop across parts of a voltage divider. Reciprocals are necessary when solving for the joint resistance of a number of unequal resistances in parallel. Perhaps you feel that paralleled resistances are seldom experienced in practice; that is true in a way, but consider the shunts across current meters. Addition, subtraction, multiplication and division, squaring and square root are found in such a simple procedure as the determination of a replacement resistor, when the available voltage, the required voltage and the current flow are known but the required resistance is unknown. The same forms of computation are required when solving for a voltmeter-multiplier resistance, and who can say that the purchase of a multiplier, rather than the improvisation of one, is justified because of lack of knowledge? Many radio problems have practical solutions that require no calculation,

but there are many other problems—simple problems to say the least—that require a knowledge of arithmetic.

Such knowledge should be instinctive. It is a matter of counting apples, the cost of a job, the discount allowed, the cost of the time spent upon a job. There is no need to consider power factor, the sine of an angle, the impedance of a transformer's primary, the cosine of an angle or the phase relation in a certain circuit; but there is a distinct need to know arithmetic in its various simple forms. Many complex radio problems can be and have been resolved into simple rules, at least sufficiently simple to provide a practical solution; but the actual solution is impossible if the simple forms of arithmetic are not understood. We have been in contact with many men who could not multiply fractions, who could not select the resistors for a voltage divider, because they could not solve ratio or percentage problems. Make a study of simple arithmetic and if you can add, multiply, subtract, divide, solve for ratios, percentages, squares and square roots, you have all of the mathematical knowledge you require to carry on successfully in radio service and maintenance work.

The technical education a man requires depends upon the work he contemplates doing; the more technical the work, the more technical must be the education. The radio receiver placed in a home is not selected according to the size of the home; it is a finished product, complete in itself. A sound installation, on the other hand, must be selected to fulfill a certain requirement. Output circuits must be designed to accommodate a predetermined number of loud speakers. The wiring from the amplifier to the speakers is more complex than that found in the average home. Versatility of operation presents a special problem in public-address systems. The solution of these problems requires more extensive radio knowledge or, should we say, audio knowledge. Such knowledge includes more complex computations, the design of "pads" and other attenuating circuits. Such work is entirely beyond the scope of the maintenance man; hence he need not know logarithms. Simple arithmetic is sufficient for him.

## Leaves From Service Men's Notebooks

(Continued from page 202)

Radiola 66-67, these have been generally done away with.

On the 33, 60 or 62, there is an opportunity for the Service Man to sell the owner on improving performance by the use of a '45 in place of the '71A. The method of doing this is too familiar for description here.

### AN ELUSIVE CASE OF FADING

By J. E. Williams

I WAS called to service a Crosley set with a Raytheon power pack, in which I had replaced the detector, the power tube, and the Raytheon tube two months before.

The set would play for a short time, then

The answers to your questions on building, testing and repairing radio sets



The three volumes of this Library cover the entire field of building, repairing and "trouble-shooting" on modern radio receivers. The Library is up-to-the-minute in every respect and is based on the very latest developments in the design and manufacture of equipment. The rapidly-growing interest in short-wave reception is thoroughly covered in a complete section which deals with the construction of this type of apparatus.

## Radio Construction Library

By JAMES A. MOYER and JOHN F. WOSTREL

Faculty, University Extension, Massachusetts Department of Education

Three Volumes — 993 Pages, 6x9  
561 Illustrations

VOLUME I: presents the fundamental principles of radio so clearly and simply that anyone of average training will be able to read, understand and apply them. In one chapter alone, it gives actual working drawings and lists of materials for the construction of eight typical sets.

VOLUME II: fully discusses all of the elementary principles of radio construction and repair. An explanation of the necessary steps for "trouble-shooting," repairing, servicing and constructing radio sets successfully.

VOLUME III: covers the essential principles underlying the operation of vacuum tubes in a non-technical a manner as is consistent with accuracy. It discusses the construction, action, reactivation, testing and use of vacuum tubes; and an interesting section is devoted to remote control of industrial processes; and precision measurements.

EXAMINE these books for 10 days FREE

This Library is not only a thorough home-study course, but a handy means of reference for the more experienced radio experimenter, repair man, and radio shop-owner. To these men, as well as to those who desire to advance in the radio profession, this offer of a 10 days' Free Examination is made.

Simply clip, fill in, and mail this coupon

McGRAW-HILL  
FREE EXAMINATION COUPON

McGRAW-HILL BOOK COMPANY, INC.,  
370 Seventh Avenue, New York.

Gentlemen—Send me the new RADIO CONSTRUCTION LIBRARY, all charges prepaid, for 10 days' Free Examination. If satisfactory I will send \$1.50 in 10 days, and \$2.00 a month until \$7.50 has been paid. If not wanted I will return them at your expense.

Name .....

Home Address .....

City and State .....

Position .....

Name of Company..... R.C. 10-30

# Train for a better Job!

## STUDY CHEMISTRY

*The field with a future!*

**W**HY should you spend your life in the hopeless rut of the untrained workman? You know that it holds no prospects for you, and some day when you realize that you have gained nothing for your years of labor, it will be too late to pull yourself out. NOW is the time to guarantee your future by getting into Chemistry—the one field that offers you boundless opportunities for a comfortable living, an enjoyable occupation, wealth and even fame.

Not an industry in the world—not a factory, mine, mill, ranch or plantation can get along without the services of chemists. Chemistry is utilized everywhere, and so many new lines of business involving Chemistry are springing up daily that there is an actual shortage of men sufficiently trained to fill the best positions.

### No Previous Experience Required

Do not think that you are barred from this attractive profession by lack of education. THE CHEMICAL INSTITUTE has taught thousands of young men, many of whom had no previous schooling of any kind. We can train you thoroughly, and may even get you your first job. The celebrated course which we give is simplified to such a point that anyone can learn who is able to read and write English. All we ask is interest in the work and willingness to devote your spare hours to it conscientiously. The course is simple to understand and enjoyable to study, but it does not skim over the essentials. You will get just as thorough instruction as if you took the same subjects in college, but it will be easier to grasp as well as far more convenient and inexpensive. No text-book could be as explicit and readily understood as our lessons. Many professional chemists use them in their own reference libraries. And in addition the personal services of able instructors will be yours at all times to help you, step by step, continually.

### Learn at Home in Spare Time

But a Chemistry student has to get practical training with laboratory apparatus! So he does, but we furnish you with the equipment needed to do your experimental work at home. You do not have to give up your present work while learning or leave home to attend classes. All your study and experiments can be done in your spare time. If you have very little leisure, we can accommodate you anyway, as every student is taught individually and may take as much time as he needs to complete the course. Even then he is entitled to specialized training and to the free services of our instructors as long as he wishes.

### Extra Laboratory Equipment Supplied Free

There is absolutely no extra charge for the comprehensive laboratory set which we furnish every student. This laboratory contains over one hundred pieces of apparatus and chemicals.

With this portable laboratory you can duplicate famous historical experiments. Think of all the pleasure it will give you! You will really be learning while playing.

### Tuition Price Reduced

Effective this month we have reduced the tuition fee, so that this splendid course and equipment are within the means of every individual who is interested in following Chemistry, whether as a career or merely as a hobby. Fee can be paid on EASY MONTHLY TERMS. The one price covers everything. There are no extras to buy.

### Plenty of Money in Chemistry

Why talk about hard times and lack of opportunities when Chemistry offers you a rich variety of ways to make a fortune? Every day the papers contain news of fresh discoveries in Chemistry, and for every one you read about, there are hundreds not recorded as news because their interest is purely technical. The manufacture of steel and other metals, of glass, pottery, soap, perfumes, fertilizers, dyes, drugs, celluloid and explosives—paper making, the tanning of leather, the refining of sugar—dairying, meat packing, preserving, sugar refining, and the preparation of hundreds of food products—all these and a multitude of other activities engage the skill of a chemical army. Don't you think there is room for you also?

Chemists are well-paid employees and each one has the opportunity of discovering new chemical secrets with a literal fortune as his reward. Every one of the lines of business in any way connected with Chemistry—and you can see that there are thousands of them—has brought wealth to the many chemists who were associated with its development. Are you going to throw away your chances for the same reward, when schooling in Chemistry can be so easy and delightful as it is through our course?

### No Exaggerated Claims

This Institute does not claim that every chemist makes millions; nor do we guarantee that you will immediately get a job paying \$10,000 a year. But many have done it and there is no reason why you cannot do it also.

### Get a Start Today!

If you would like to know more about Chemistry, and if you are sincere in your desire to get out of the rut and if you have ambition enough to want to become a famous chemist some day, you will not wait until tomorrow to find out.



MR. CHARLES W. SUTTLE, of Forgan, Okla. (at left on top), is deeply interested in chemical research. He performs his experimental work in his well-equipped home laboratory.

MR. O. T. D. BRANDT, of Seattle, Wash. (center photograph), is an analytical chemist of demonstrated ability. In his home he has equipped a laboratory containing several thousand dollars' worth of equipment, bought entirely with earnings from spare-time work while he was taking our course.

MR. VIRGIL REDGATE, of Hutchinson, Kans. (bottom right-hand photo), began doing professional analysis on commission, even before he completed his course. He is also the inventor of several devices and processes used in photography.

### DIPLOMA AWARDED EVERY GRADUATE

Upon graduation every student is awarded our Diploma in Chemistry, certifying that he has successfully completed his studies. Your name on this certificate will be a source of pride to you all your life, as well as an aid in obtaining a position.

MAIL THIS COUPON

TODAY

FOR FREE BOOK!



CHEMICAL INSTITUTE OF NEW YORK, Inc.

19 Park Place . . . . . New York, N. Y.

CHEMICAL INSTITUTE OF NEW YORK, Inc.  
Home Extension Division  
19 Park Place, New York, N. Y.

Please send me at once, without any obligation on my part, your Free Book, "Opportunities for Chemists," and full particulars about the Experimental Equipment given to every student. Also please tell me about your plan of payment and the reduction in the tuition price.

NAME .....

ADDRESS .....

CITY..... STATE.....

RC-10-30

the volume would fade out. I tested all the tubes and found them all right; but replaced them with others, without improvement.

The owner wished me to fix the set at his house; but I convinced him that it would be cheaper for me to take it to the shop, as I could then let it play while doing other work, and observe the meters upon my tester when the signal faded out. It played for an hour in normal manner. The set quit, and I noticed that the filament voltage of the '26 tubes dropped. Testing the wiring from the power pack to each tube failed to show anything wrong. As the wiring in the set seemed all right I disconnected the condenser across the filament without any improvement. I then noticed that shaking the power pack would bring the signals back to normal.

I took the case off of the power pack and pulled at the wires, and one came out at the plug connection.

**YOU NEVER CAN TELL**

By J. M. Francis

WHEN I read Mr. Janosko's article on "Reducing Static and Interference" in July RADIO-CRAFT, it didn't make much impression on me. The theory was good, but I was not interested.

Yesterday I got a service call; and I knew from the location that the trouble was more than likely to be outside interference. When I arrived, the owner told me that he had had the set for two weeks, but that it had been so noisy that they had no pleasure from it. I listened a while and knew what the noise was. Within two blocks of the house is the substation of the local power company with three rotary converters; in another direction, half a block away, is a high-tension line carrying 22,000 volts.

It looked like a hopeless job till I remembered Mr. Janosko's article. I got 125 feet of No. 10 rubber-covered wire, and wound it around the aerial; I then grounded the bare wire and connected the lead-in to the No. 10.

The result surprised me; there is no longer any interference from the converters or the high-tension line.

I just thought others would like to know how it worked out.

**SERVICING THE ATWATER KENT**

By Leo L. Beranek

IF the tone is distorted, and the volume had, the plate voltages are low and the grid voltages high, on an Atwater Kent screen-grid model, a thorough checking of the "C" bias on the power tube will show an open in this biasing resistor, which should be replaced.

Recently a set of this model was brought in for repair; there was no voltage on the plate of the first A.F. tube. The continuity of the plate circuit was correct; a reading from the ground to the plate indicated that the cathode circuit was open. It was found that the nut holding the first A.F. biasing resistor to the frame was loose; and tightening it did the trick.

On several screen-grid sets, there was an absence of plate voltage on the '27s; though other sockets gave proper readings. On tracing the red wire from the rectifier, a drop of solder was found touching the frame

of the set, near the group of three resistors.

A screen-grid set suddenly and irregularly cut its volume. We concluded that poor ground connections throughout the set were causing the trouble. After removing the R.F. coil shields, and tightening the bolt holding the solder lug to which one side of the R.F. coil is connected, the defect was remedied. If a "Model 55" or "60" cuts off all signals when the "Local-Distance" switch is in one position, and performs properly on the other, check the plate voltage to the first R.F. socket for an open circuit. You may find a poor solder connection on the primary of the second R.F. transformer, where the coil-winding ends are soldered to the rivet eyelets of the coil form.

The "Distance" switch condenser consists of two enamelled wires, about eight inches long, twisted together and encased in a rubber insulating tube. One of the pair is soldered to the switch and the other, at the opposite end, to a by-pass condenser terminal.

A dynamic reproducer was found to operate satisfactorily until a little volume was used; then it would stop. A break in the voice coil was found, and soldering this remedied the trouble.

On several A. K. sets employing magnetic speakers, choking was noticed on both vocal and instrumental reproduction. This was traced to the speaker filter condenser (the plate voltage on the last A.F. tube had fallen to 100 volts) and replacing this remedied the trouble.

**UNUSUAL SERVICE PROBLEMS**

By Guy Newell

AFTER spending more time than I could afford to waste waiting for a late-model electric receiver to perform (said performance being described as fading out and coming back with a crash) I was lucky enough to have the lady of the house say, "Oh, you have it on 'distance'; we always keep it on medium. 'Distance' is too loud, and 'local' is not loud enough." There was no "medium" marked on this "local-distance" switch; but when it was set at the middle point the set worked with medium volume—and cut in or out with every heavy vibration.

Another receiver of much the same type, using two '45 tubes in push-pull, gave out a very unpleasant whistle or howl from the time the set was turned on until the tubes were warm. Several receivers with the same trouble have been encountered since that time, and the remedy was the same in every case. They were "fussy" about the '45 tubes, and a tube that tested good and worked perfectly in another type of set made trouble in that model. Limited experimenting has shown that about one of four tubes acts this way.

One evening recently, at the home of a friend the writer was requested to look at the radio set—a screen-grid outfit with the usual three screen-grid tubes—and, of course, there was no test equipment available. The three tubes already mentioned were removed from the set, the set turned on and tuned to the most powerful station available; then each of the tubes was tested by inserting it in the socket next to the detector, attaching the top cap, and holding the bare end of the antenna in contact with

**New Developments!**

**Complete Instructions and Data on All Recent Radio Inventions Now Yours for Ready Reference in This One Big Guide Book of Radio**

**BYRD'S ANTARCTIC RADIO EQUIPMENT**—Receivers, transmitters and latest navigation aids used on this special flight fully described.

**TELEVISION**—Mr. C. F. Jenkins, father of television and radio movies, gives you in his own words complete directions for building practical television equipment.

**INTERFERENCE ELIMINATION**—New methods systematically outlined by W. F. Fleming, radio engineer.

**RADIO AUTO-ALARM**—Description of new device for ships which keeps the SOS watch while operator is off duty.

**SHORT-WAVE APPARATUS**—Commercial and amateur, described and illustrated.

**NEW BROADCASTING EQUIPMENT**—Temperature-controlled piezo crystal oscillator; 100 per cent. modulation panel and other new apparatus.

—and these are only a few of the NEW subjects added to the most complete radio handbook ever published—

**THE RADIO MANUAL**

**A Handbook for Students, Amateurs, Operators and Inspectors**



Here's the answer to every question about the principles, operation, and maintenance of apparatus for radio transmitting and receiving. Important new chapters have been added to bring it right up to the minute. Many new photographs and diagrams have been included. It is now more than ever the one complete handbook covering the entire radio field.

**A Complete Course in Radio Operation in ONE VOLUME**

**Prepares for Government License**

20 big chapters cover: Elementary Electricity and Magnetism; Motors and Generators; Storage Batteries and Charging Circuits; The Vacuum Tube; Circuits Employed in Vacuum Tube Transmitters; Modulating Systems and 100 Per Cent. Modulation; Wave-Meters; Piezo-Electric Oscillators; Wave Traps; Marine Vacuum Tube Transmitters; Radio Broadcasting Equipment; Arc Transmitters; Spark Transmitters; Commercial Radio Receivers; Marconi Auto-Alarm; Radio Beacons and Direction Finders; Aircraft Radio Equipment; Practical Television and Radio Movies; Eliminating Radio Interference; Radio Laws and Regulations; Handling and Abstracting Traffic.

**Prepared by Official Examining Officer**

The author, G. E. Sterling, is Radio Inspector and Examining Officer, Radio Division, U. S. Dept. of Commerce. The book has been edited in detail by Robert S. Kruss, for five years Technical Editor of Q S T, the Magazine of the American Radio Relay League, now Radio Consultant. Many other experts assisted them.

**Examine it FREE!**

The 1930 edition of "The Radio Manual" is now ready. Nearly 800 pages; 369 illustrations. Bound in flexible Fabrikoid. The coupon brings the volume for free examination. Within 10 days you may return the volume or send the price of \$6.00.

**MAIL THIS COUPON**

D. Van Nostrand Co., Inc.,  
250 Fourth Ave., New York.

Send me the Revised Edition of THE RADIO MANUAL for examination. Within ten days after receipt I will either return the volume or send you \$6.00, the price in full. (R.C. 10-30)

Name .....

Street and No. ....

City and State .....

# "Official" RADIO SERVICE MANUAL

## A Complete Directory of all Wiring Diagrams of Commercial Receivers

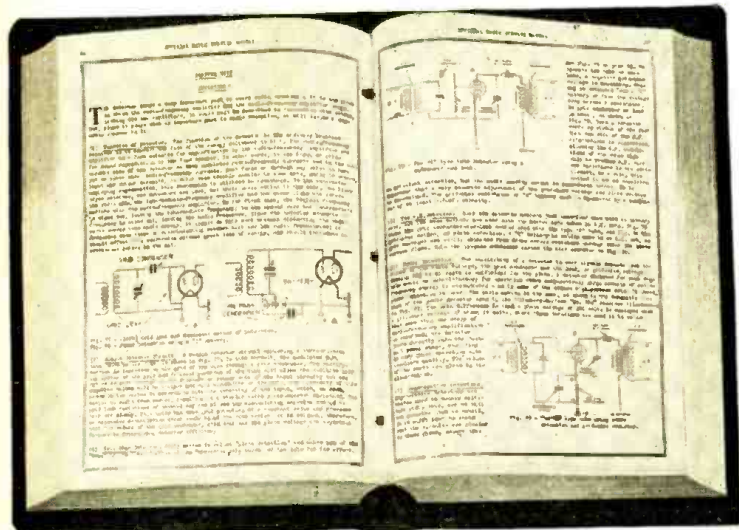

650 DIAGRAMS  
352 PAGES 9" x 12"  
Weight 2½ lbs.

HUGO GERNSBACK, *Editor*  
CLYDE FITCH, *Managing Editor*

### Prepared Especially for the Radio Service Man!

**\$3.50** A COPY

**N**EVER in the history of radio has there ever been published a service manual, so complete, as this new OFFICIAL RADIO SERVICE MANUAL. It is a veritable encyclopedia of service information—worth several times its price, not only for the Service Man, but for everyone interested in radio. There has been collected wiring diagrams and data of nearly every commercial set, of which there is any available record, manufactured since 1927, and many earlier ones. The OFFICIAL RADIO SERVICE MANUAL is made in loose-leaf form in a handsome, durable, flexible leatherette binder and contains 352 pages of the large size, 9 x 12. Despite its tremendous size the entire book can be folded and slipped into your pocket or bag. Additional service data for new receivers, as they appear on the market, will be published and supplied at a trifling cost; so that the MANUAL may be kept up-to-date at all times.

### SERVICE INFORMATION

But that is not all. The OFFICIAL RADIO SERVICE MANUAL contains also a most comprehensive instruction course for the radio Service Man, giving practical information from every angle on how to service sets. Here are only a small number of the articles mentioned:

- |                              |                            |
|------------------------------|----------------------------|
| Amplifiers (Audio and Radio) | Power Supply Systems       |
| Automotive Radio             | Radio Phonograph Equipment |
| Antennas                     | Resistors                  |
| Condensers                   | Short-Wave Sets            |
| Detectors                    | Speakers                   |
| Eliminators                  | Tubes                      |
| Meters                       |                            |

In short, the OFFICIAL RADIO SERVICE MANUAL is the biggest thing of its kind that ever came along in radio. It will be hailed by every wide-awake radio man throughout the entire industry. The size of the Manual is 9 by 12 inches. There are 352 pages—hundreds of diagrams—illustrations and sketches.

### NOW ON SALE

*A limited supply of the first printing are ready for distribution, and at the unusual low price of \$3.50 for this Radio Service Manual. Every Service Man should have one at his disposal.*

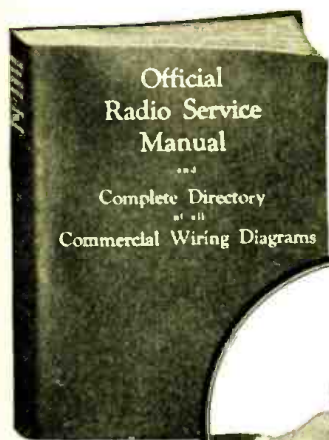

GERNSBACK PUBLICATIONS, Inc.,  
96-98 Park Place, New York, N. Y.

RC-10

As per your special offer, I enclose herewith \$3.50 for which you are to send me postpaid, one copy of the OFFICIAL RADIO SERVICE MANUAL.

Name .....  
Address .....  
City..... State.....



this cap. Two good tubes gave fair volume, and the bad tube gave nothing. Then the socket nearest the antenna binding post was left vacant; the two good tubes inserted in the remaining sockets with the caps attached; and the antenna was attached to the cap of the first tube. Good reception was had from all local stations until a new tube could be obtained.

Another of the fading screen-grid receivers, on which three other men had worked without success, was found to have on one of the tubes a loose metal cap which made and broke contact, from either heat or vibration.

In checking up an old battery-operated radio, a telephone-type lightning arrester was found to form a perfect short circuit across the antenna and ground. After this was removed, the quality of sound was still very poor; and it was learned that the polarity of the speaker on an extension cord made all the difference between good and bad reception. This same speaker, used without an extension cord, gave good reproduction regardless of polarity.

**VARYING RESISTOR VALUES**

By C. N. Austin

**I**N a Steinite 70 it was found that, after the tubes had warmed up, if the set was turned off for about ten seconds, then a

signal previously at normal volume would come in with deafening loudness, then fade. Tubes were O.K.; but a set analyzer showed that under the conditions described, the voltage on the screen-grids of the R.F. amplifier was about ten per cent. higher for a short time than when the set had been turned off. Measurement showed that, as the resistor supplying this voltage cooled, its resistance increased materially.

A particular case of interference here in Portland, Oregon, caused trouble and eluded discovery for months. The electric company made several attempts to find it and even changed the house-supply transformer. I drew the job of hooking up a new set, and luckily found the trouble.

Speech and music was all chopped up, as if a telegraph key had been used to cut the signals; it was evident that the trouble came from the electric line. After testing all light fixtures, I examined the electric stove and water heater which the customer had. The stove was all right, and the heater had not been used for two months. At last, a member of the family turned the cold water on and off suddenly, and this caused an increase in the interference. After locating the trouble in the conduit connecting to the heater, we notified the lighting company; the connections were repaired, and we sold the customer a very expensive radio.

**The Service Man's Open Forum**

(Continued from page 202)

with all technical and no practical experience. I have been in radio twelve years.

I think RADIO-CRAFT the best thing on the newsstands, and would rather miss a good meal than it.

CYRIL J. HENRY, W9BIE,  
Brighton, Iowa.

**WANTS A WEEKLY**

Editor, RADIO-CRAFT:

I must say that words cannot express how well your magazine is appreciated by one who is always interested in radio and the latest in radio development. I am very sorry that it does not come out weekly. I have never subscribed; but I can't be patient until next month's RADIO-CRAFT comes out. Sometimes it gets here late, but I keep watch on the newsstands. I am in the near future going to send in my subscription. (A time-, money- and worry-saving idea.—Editor.)

I have only been at the service game for the last two years. I have certainly put a great deal of my time into study. I have to work eight hours per day and then come home and put in six or seven more hours in study; so you see I am very much interested. Thanking you for the assistance RADIO-CRAFT has given to Service Men throughout the entire nation.

CECIL C. WALDEN,  
3462 Farmville Ave.,  
Memphis, Tennessee.

**SERVICING IN ALASKA**

Editor, RADIO-CRAFT:

I have been following with interest the letters on the relationship between Service Men and the manufacturers. I believe I can see some point to both sides of the

question, but in my opinion the locality has a great deal more to do with it than has been brought out.

In the case of manufacturers who, evidently, do not expect to sell very many sets, and those only in localities where they can have competent Service Men of their own, their policy seems to me O. K.

Further, in the case of all manufacturers, there is always the possibility that some "haywire, screwdriver and pliers," so-called Service Man may get hold of their data and do more harm than good. However, I believe Service Men (?) of that type will eliminate themselves and, even at that, are less likely to damage the set if they have some instructions from the manufacturer than if they try to "prod" around aimlessly.

On the other hand there are many cases away from the larger centers—and that is especially true here—where if servicing is to be done it must be done by an independent Service Man. In such cases, even those manufacturers who send particulars of any given model on request but refuse to furnish complete data on the whole line are bucking their own interests. If, every time I had a different model to work on, I had to send for data on it and wait three weeks (thanks to mail service) for it before I could work—and then find I needed a certain part about which I would either have to argue with the manufacturer or get the dealer to send for it—the customer would certainly not recommend that set to his friends.

Luckily, to date, I have been able to get the necessary data from my files—various periodicals, books, etc.—on all except one set; and in that case, which incidentally

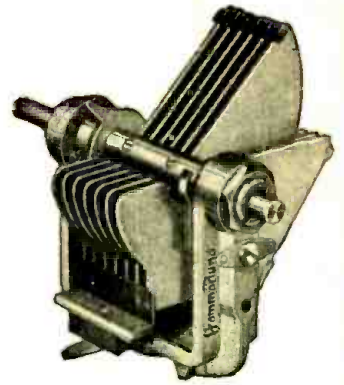

*A New and Better Condenser*  
**For SHORT-WAVE Work**

Heavy, widely-spaced plates for strength. Less chance for accumulation of dust effecting capacity changes in close tuning.

"Parmica" insulation, the remarkable new material which so closely matches the ideal dielectric efficiency of dry air. Current loss greatly reduced; sensitivity and selectivity much improved. Double-cone, smooth-operating bearings—easily adjusted for wear, non-corrosive brass plates with tie-bars. Strong aluminum alloy frame.

A REAL short-wave condenser in the three most desirable sizes: 150, 125 and 100 mmf.

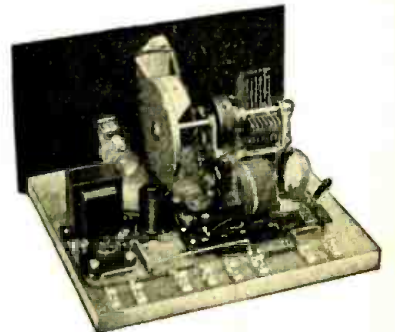

**Here's Fun for the SHORT-WAVE Fan**

A remarkable efficient two-tube distance getter, with regenerative detector and one audio-stage. Designed for use with the new 230-type, 2-volt battery tubes. Easily constructed from the Hammarlund kit, containing all parts, as illustrated.

It includes the famous Hammarlund Drum Dial, the new Hammarlund wide-spaced short-wave "M.dline" condenser and the improved Hammarlund space-wound plug-in coils.

Covers range of 15 to 105 meters. Coils for other wave-lengths available. Makes a wonderful tuning unit for the short-wave experimenter.

Write Dept. RC10 for Details of Hammarlund Short-Wave Equipment.

**HAMMARLUND MFG. CO.**  
424-438 W. 33rd Street New York



was not one of my jobs, the man wrote three times and waited three months before he finally got a circuit diagram. It happened to be a set put out by a mail-order house in Chicago (radio, parts etc.).

Another thing I would like to register a protest on is relative to those manufacturers who believe that, when they supply a magazine with the circuit diagram, they have done their duty. Some of them fail to give any of the values (ohmic, etc.) That, in my opinion, is an important point and should be given in every case, though it is not. I do not believe the magazine is at fault; because one circuit will have those values and another on the same page will not, which would seem to indicate one manufacturer furnished them and the other did not.

R. B. OXRIEDER,  
Juneau, Alaska.

**SERVICING IN ENGLAND**

Editor, RADIO-CRAFT:

I would like to state how useful RADIO-CRAFT is to us service engineers at the Gramophone Co., Hayes, Middlesex. I was the first to see it on a bookstall, and introduced it to our department. The chief caused a circular letter to be sent to all service engineers, recommending it for their regular perusal. We all look forward to it every month with very great interest. Those who read it regularly can always be sure of being ahead of any "radio experts" we

may meet in our travels. Wishing RADIO-CRAFT the best of success, I am

Yours faithfully,  
E. J. G. LEWIS,  
40, Grange Park, Ealing,  
London, W5, England.

(Mr. Lewis accompanied his very kind letter with an account of servicing conditions in England, too long for publication here. We gather, however, that the independent Service Man is practically non-existent in England, between the factory service representatives and the home set builders, who are still flourishing in great vigor. The use of radio-phonograph combinations has been increasing rapidly in that country.—Editor.)

**Automotive Radio Servicing**

(Continued from page 203)

the R.F. transformers to match the gang condenser. Any meter with a full-scale deflection between one and ten mills. is placed in series with the green detector lead of the cable at the battery box and the 22½-volt tap of the "B" batteries. The detector voltage must never exceed 22½ while these adjustments are being made, or a blown meter will result.

When a strong local signal is tuned in, the detector plate current will drop to about one-third its normal value. This reduction

in plate current is directly proportional to the R.M.S. input voltage, or signal intensity. Changes in the tuning of the receiver, too slight to be noticed by the ear, will cause a very decided change in the detector-plate current.

To adjust the receiver, the coil trimmers should be unscrewed as far as they will go. A signal of about 1100 kilocycles should be tuned in, and the dial setting at the lowest value of the detector plate current noted. The dial is then rotated one degree, in a counter-clockwise direction, and left there until the conclusion of the test. Starting with the third R.F. transformer, the trimmers are all adjusted to cause the lowest reading of the milliammeter; each is screwed in until the point is reached where further turning will cause the current to rise. If the current either rises or remains constant when a trimmer is screwed in, it should be left out. When the trimmers are properly set, one turn to the right or left will cause a visible deflection of the meter. It may be necessary to repeat this operation three or four times before proper results are obtained. While this method is much better than tuning by ear, it is much slower and less accurate than the use of an oscillator.

**Increasing Sensitivity**

In districts outside the radio congestion of the big cities, where extreme selectivity is not required, the volume of received stations may be increased by removing the

**JOHN F. RIDER**

*announces*

a personally written and personally conducted

**ADVANCED HOME STUDY COURSE**

for serious minded

**RADIO SERVICE MEN**

**EXPERIMENTERS**

**PROFESSIONAL SET BUILDERS**

who wish to increase their earning power, prepare for future radio developments and better their financial condition.

JOHN F. RIDER, 1440 Broadway, New York City.

Dear Mr. Rider:

Please send to me all details about your ADVANCED HOME STUDY COURSE without any obligation upon my part.

Name .....

Address .....

City ..... State.....

R.F. unit from its case and moving the ground connection of the first R.F. transformer to the unused terminal. This of course, increases the number of turns in the antenna coil, giving slightly increased range to the set with a slight sacrifice of selectivity. However, it is not advisable to make this change if the set is to be used in a community where there are a large number of local broadcast stations in operation.

Another way to increase the range of an automotive radio is to add an extra length of copper screen in the top, insulated from the original screen by a layer of felt padding, which is obtainable from any shop dealing in tops. These two screens are soldered together at the rear of the car, and the lead-in is taken off either the upper or lower screen. In making this installation, holes must be cut in the original screen where the second is to be tacked to the bow, in order to prevent shorting them.

**What is a Reliable Tube Test?**

*(Continued from page 205)*

results on all kinds of tubes. We are continuing this investigation and, at present, have several new types of testers that we are working on and that perhaps might prove satisfactory. If they do, and their cost is within reason, we will pass the information on to you. At the present time, the very best way of testing a tube returned to you by a dealer is to try it in a receiver.

"An extract from a report of our research department on tube testing runs: 'It seems to be the general opinion among vacuum-tube engineers and others who have had contact with the testing of radio tubes in the field, that there is no simple form of apparatus yet available that will satisfactorily analyze a radio tube, enabling a Service Man to determine definitely whether a tube will operate in the radio set or not. It is quite possible that a tube which measures O. K. on a tester will not perform when placed in a radio set.'

"Inasmuch as Philco tubes are designed to operate in Philco sets, it would appear that the best test is the performance of the tube in the set. While not absolutely a perfect check, it should certainly give far better results than can be accomplished with most tube checkers designed for field use."

This positive declaration will undoubtedly arouse much interest among Service Men, and even more among the manufacturers of precision testing apparatus, designed for checking tubes. Their reply will surely be quickly forthcoming.

**RADIO ON THE ROAD**

**S**AYS *Variety*, which has its finger always on the pulse of industries dealing with entertainment and amusement: "Consensus of opinion among the retail dealers, in both sheet music and phonograph records, is that radio, as never before, is asserting itself as a dangerous competitor to their business. Increasing popularity of music "as you ride" in the family motor is helping to keep the public out on the highways, especially in California."

**It SATISFIES  
the Most Critical**

Licensed under  
U. S. Pats. Pend. and  
Canadian Pats.  
281172 and 286778

**Super-  
TONATROL**

**The Superior 5-watt  
All-Purpose Voltage  
and Volume Control**

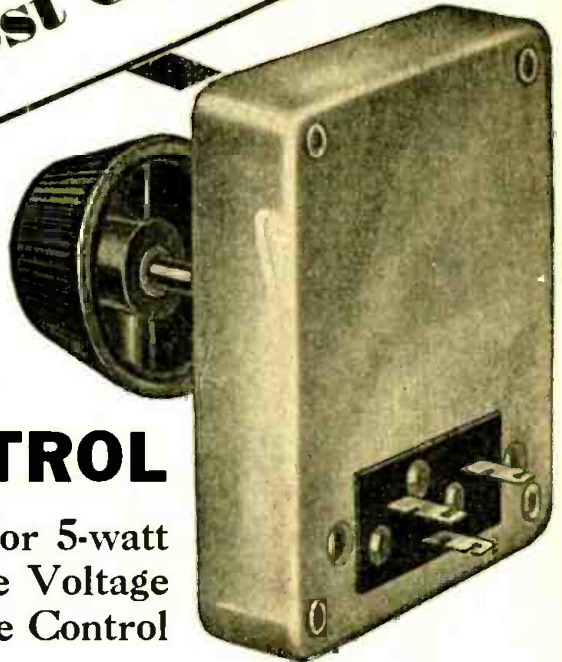

**"YOU** can't beat the Super-TONATROL for performance," say radio engineers, experimenters, service men all over the world. And rightly too, for the Super-TONATROL has distinctive qualities no other volume control can offer. Smoother variation—absolutely stepless—quiet—the Super-TONATROL is aptly termed "The world's most perfect volume control."



7 types—for all usual requirements \$2.40 to \$3.50. Also 2-3 gang manufacturers' models for all purposes.

*Built on the New  
DURATROL Principle*

A new type resistance element is permanently fused to a vitreous enamelled metal plate, over which floats, by direct contact, a pure silver multiple brush with delightful smoothness.

So firm is the resistance element, and so smooth the floating contact, that Super-TONATROL units under load have withstood over 100,000 oscillations of the contact without showing appreciable signs of wear or variation in resistance value. Metal cover aids rapid heat dissipation.

*Better Resistors and Voltage Controls for  
Every Radio and Power Supply Purpose*

Electrad manufactures a complete line of resistors and voltage controls for every radio and power supply purpose, including TELEVISION.

Superior engineering facilities and efficiently organized mass production to meet world-wide demand effects substantial savings in original manufacturing costs—savings which are expressed in ELECTRAD'S fine quality at moderate prices.

175 Varick St., New York, N.Y.  
**ELECTRAD**  
INC.

**MAIL COUPON FOR SUPER-TONATROL CIRCULAR**  
ELECTRAD INC., Dept. RC-10, 175 Varick St., New York, N. Y.  
Please send free Super-TONATROL Circular showing recommended uses.  Check here for information on Complete Electrad Line.  
Name.....  
Address.....

# Simple Mathematics for the Service Man

(Part II)

By Boris S. Naimark

The amplification constant of a tube—written as  $\mu$  and pronounced "mu"—may be defined as the ratio of the change in plate voltage, which is necessary to produce a certain change in the plate current, to the change in grid voltage which will produce the same change in the plate current. Structurally, the "mu" of a tube depends upon the mesh of the grid and upon the spacing between the grid and plate. Electrically it denotes the maximum theoretical voltage amplification possible or available within the tube.

The plate impedance or plate resistance of a tube may be defined as the ratio of change in the plate voltage to the change in plate current, and is expressed in ohms. In tube charts the specified values of plate impedance are the A.C. values; the D.C. values of plate resistance are equal to twice the value of the A.C. plate resistance.

Mutual conductance—indicated as  $G_m$ —may be defined as the ratio of the change in plate current to the change in grid voltage, and is ordinarily expressed in micromhos.

By the external impedance of a tube is meant the impedance of the coupling unit or device which is connected between the plate and the filament of the tube. Considerations of external impedance are of paramount importance; since the relation between the value of a tube's plate impedance, and the impedance of its external plate-to-filament circuit, governs the power output as well as the voltage amplification obtainable from a given tube or tubes. In this connection, it is of interest that the

# THE RADIO EXPERIMENTER'S MAGAZINE

Contains more material than a \$2.50 book, yet the price is but 50c. a copy.

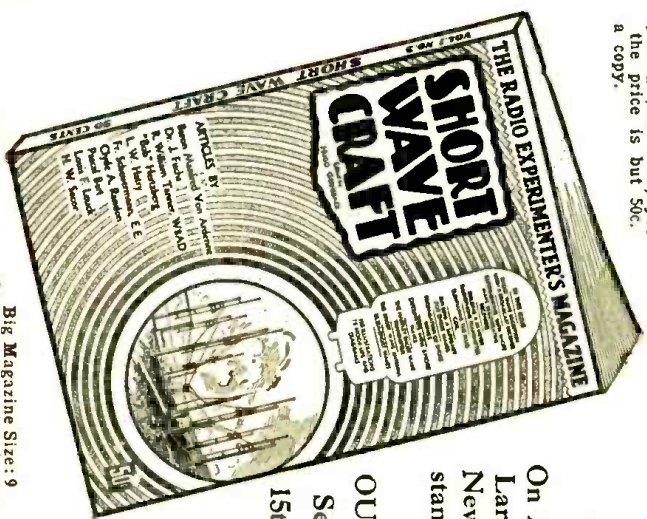

Big Magazine Size: 9 by 12 inches, printed on a heavy grade of book paper, with a beautiful cover in four colors—that's SHORT WAVE CRAFT.

On All Large News-stands  
 Sept. 15th  
 OUT

## PARTIAL CONTENTS In Short-Wave Craft No. 3 October-November Issue

SHORT WAVE CRAFT, Mr. Hugo Gernsback's latest radio magazine, has been called his greatest achievement in radio magazine publishing.

SHORT WAVE CRAFT is the one and only real big magazine on short waves you have wished for so long. HERE IS PROOF!

The Use of Ultra Short Waves for Television, by Baron Manfred Von Ardenne  
 Propagation of Radio Waves, by Dr. J. Fuchs  
 Building a 20-Meter Radio Transmitter, by R. Wm. Tanner, W8AD  
 How You Can Make Money by Building Short Wave Sets, by "Bob" Herzberg  
 How to Build the Hy-7 Short Wave Super-Heterodyne, by L. W. Harty, Radio Engineer  
 Short Wave Reception with a Broadcast Receiver, by Fr. Schuermann, E.E.  
 Experimenting with Short Wave Regenerative Receiving Circuits, by Clyde A. Randon  
 A Short Wave Receiver Built in a Clear Box—An Article for the Beginner, by Louis F. Leuck

Experiments with 4-Inch Waves, by Pascal Bert  
 How a New York Newspaper Sent Facsimile Pages Via Short Wave Photradio, by H. Winfield Secor, E.E.  
 Eliminating the Plug-In Coil—Two New Methods Illustrated and Described

Besides these outstanding features, SHORT WAVE CRAFT No. 3 is chock full of how-to-make-it and constructional articles on Short Wave Transmitters and Receivers, both for code and phone.

Regular Departments in SHORT WAVE CRAFT  
 Photographic Section—pictures of latest short wave sets and stations  
 Transmitters for Short Waves—How to build them

VACUUM-TUBE FORMULAS

Amplification constant ( $\mu$ )  $\mu = \frac{\text{Change in Plate Voltage } (E_p)}{\text{Change in Grid Voltage } (E_g)}$

Plate Impedance (in ohms)  $Z_p = \frac{\text{Change in Plate Voltage } (E_p)}{\text{Change in Plate Current } (I_p)}$

Mutual Conductance  $G_m = \frac{\text{Change in Plate Current } (I_p)}{\text{Change in Grid Voltage } (E_g)}$

When the Plate Current is measured in Amperes; the Mutual Conductance is in MICROMHOS =  $\frac{\mu}{Z_p} \times 1,000,000$

When  $E_g$  is the Input Voltage,  $Z_p$  is the Plate Impedance and  $Z_L$  is the External Plate Impedance or Load Impedance, the

Voltage Amplification =  $\frac{\mu \times E_g \times R_p}{Z_p + R_p}$

POWER OUTPUT

When  $E_g$  expresses the RMS (Root-Mean-Square) Effective Value of the A. C. Input, the

POWER OUTPUT =  $\frac{\mu^2 \times E_g^2 \times R_p}{(Z_p + R_p)^2}$

The MAXIMUM Power Output is  $\frac{\mu^2 \times E_g^2}{4r_p}$  The MAXIMUM UNDISTORTED Power Output is  $\frac{2\mu^2 \times E_g^2}{9r_p}$

When  $E_g$  is the Maximum (Peak) A. C. Input Value

The Maximum Undistorted Power Output is  $\frac{\mu^2 \times E_g^2}{9r_p}$

OSCILLATORY CIRCUIT VALUES

Where  $\lambda$  ("lambda") is the WAVELENGTH in meters, L is the Inductance in MICROHENRIES and C is the Capacity in MICROFARADS.

The RESONANT FREQUENCY (in cycles) is  $F_r = \frac{159,160}{\sqrt{L \times C}}$

The DECREMENT of a Circuit is ( $\delta$ ) "delta" =  $\frac{R}{2\pi f L} = 3.1416 \times \frac{R}{\lambda L}$

Where the POWER FACTOR is  $\frac{R}{\lambda L}$

The Resonant Frequency of a PARALLEL Circuit is  $f_r = 0.159 \sqrt{\frac{C}{L}}$

TRANSFORMER RATIOS

The Voltage across the Secondary =  $\frac{\text{The Number of Secondary Turns}}{\text{The Number of Primary Turns}} \times \text{The Voltage across the Primary}$

A chart of formulas which may come in handy at any time.

Short Wave Receivers—Construction data for all types and kinds  
 The Short Wave Experimenter  
 The Short Wave Beginner  
 Television on Short Waves  
 Short Waves for the Broadcast Listener  
 Ultra Short Wave Sets  
 Aircraft Short Wave Aerials  
 How to Build Short Wave Aerials  
 Short Wave Question Box

PUBLISHED ON THE 15th OF EVERY OTHER MONTH

Extra Special Offer Void  
 After October 15th

The regular subscription price to SHORT WAVE CRAFT is \$3.00 a year. But up to October 15th, we will accept \$1.90 for a full year's subscription (Canada and foreign, \$2.00) AND IN ADDITION will send you FREE the first two issues of SHORT WAVE CRAFT. This will give you in reality a subscription of one year and three months, value \$4.00, for \$1.80!

MAIL COUPON TODAY!

SHORT WAVE CRAFT  
 96-98 Park Place, New York, N. Y.

As per your special offer I enclose \$1.90 for my subscription for one year to SHORT WAVE CRAFT and send me also the first two issues gratis.

NAME \_\_\_\_\_  
 ADDRESS \_\_\_\_\_  
 CITY \_\_\_\_\_  
 STATE \_\_\_\_\_

plate impedance of two tubes connected in parallel is just half of the plate impedance of one of the individual tubes; while the plate impedance of two tubes connected in push-pull is equal to twice the impedance of one of the tubes. (The above is true only when two identical tubes are used.) It can be shown that the full value of the "mu" of a tube can be obtained only when the value of the external impedance is infinite.

#### Power Output

In practice, ninety per cent. of the "mu" of a tube is available when the external impedance is between five and ten times as great as the tube's plate impedance. The maximum *undistorted* power output of a tube is available only when the value of the external impedance is equal to twice the tube plate impedance.

In addition to the "mu," and the external and internal plate impedances of a tube, the power output depends upon the value of the signal input voltage. Doubling the value of the signal input voltage doubles the voltage output of a tube; but it quadruples the tube power output. In other words, voltage amplification is directly proportional to the signal input voltage; whereas the power output of a tube is directly proportional to the *square* of the signal input voltage. It should be understood that power tubes supply the full rated maximum undistorted power output only when operated at or near the specified maximum safe plate voltages and when the input peak signal voltage is equal to the recommended grid bias.

A study of tubes discloses the fact that tubes having comparatively high values of "mu," and therefore high values of plate impedance, are most suitable for voltage amplification. Tubes having low values of "mu," and correspondingly low values of plate impedance, show better power handling capacity, and are more suitable for the output, or power stage of a radio receiver.

A study of circuit formulas is beyond the scope of this article; though we present some of them in our chart, those who would learn the significance of them are referred to any standard text on radio.

## Junior Service Man

(Continued from page 208)

tube, and there is any question that the tube is operating, merely place your hand upon it after it has been turned on for ten minutes; if it is warm, you may be sure that the tube is operating, even though no click is heard from the speaker.

Another simple test of the efficiency of an antenna, when the set in question is known to be in good condition and the tubes are all right, but the volume is weak: place the finger on the antenna post of the set. If there is an increase in volume, this indicates that the antenna is too short or is defective. Make changes in it until there is no change in volume when the finger is placed on the antenna post.

Here is a test for a "B" power unit which can be made with material found in every workshop. Hook up a 25-watt electric light bulb in series with two leads; so that, when

# PATENTS INVENTORS



MY PATENT  
LAW OFFICES  
OPPOSITE  
U.S. PATENT  
OFFICE

Write for these  
**FREE BOOKS!**

At the left is a view of my drafting and specification offices where a large staff of experienced experts is in my constant employ. All drawings and specifications are prepared in my offices.

## Protect Your Ideas Take the First Step Today

If you have a useful, practical, novel idea for any new article or for an improvement on an old one, you should communicate with a competent Registered Patent Attorney AT ONCE. Every year thousands of applications for patents are filed in the U. S. Patent Office. Frequently two or more applications are made for the same or substantially the same idea (even though the inventors may live in different sections of the country and be entirely unknown to one another). In such a case, the burden of proof rests upon the last application filed. Delays of even a few days in filing the application sometimes mean the loss of a patent. So lose no time. Get in touch with me at once by mailing the coupon below.

### Prompt, Careful, Efficient Service

This large, experienced organization devotes its entire time and attention to patent and trademark cases. Our offices are directly across the street from the U. S. Patent Office. We understand the technicalities of patent law. We know the rules and requirements of the Patent Office. We can proceed in the quickest, safest and best ways in preparing an application for a patent covering your idea. Our success has been built on the strength of careful, efficient, satisfactory service to inventors and trademark owners located in every state in the Union.

### Strict Secrecy Preserved— Write Me in Confidence

All communications, sketches, drawings, etc., are held in strictest confidence in strong, steel, fire-proof files, which are accessible only to authorized members of my staff. Feel free to write me fully and frankly. It is probable that I can help you. Highest references. But FIRST—clip the coupon and get my free book. Do THAT right now.

### No Charge for Information on How to Proceed

The booklet shown here contains valuable information relating to patent procedure that every inventor should have. And with it I will also send you my "Record of Invention" form, on which you can sketch your idea and establish its date before a witness. Such evidence may later prove valuable to you. Simply mail the coupon and I will send you the booklet and the "Record of Invention" form, together with detailed information on how to proceed and the costs involved. Do this NOW. No need to lose a minute's time. The coupon will bring you complete information entirely without charge or obligation.

**Clarence A. O'Brien**  
Registered Patent Attorney

Member of Bar of Supreme Court of the United States; Court of Appeals, District of Columbia; Supreme Court, District of Columbia; United States Court of Claims.  
Practice confined exclusively to Patents, Trademarks, and Copyrights



Mail this Coupon NOW

**CLARENCE A. O'BRIEN**

Registered Patent Attorney

3507 Security Savings and Comm'l Bank Bldg.,  
Washington, D. C.

— or —  
Suite 1106, Dept. K-3, Woolworth Bldg., New  
York City

Please send me your free book, "How to Obtain a Patent," and your "Record of Invention" form without any cost or obligation on my part.

Name .....

Address .....

(Important: Print or Write name clearly and address office nearest you)

**EVERY  
SERVICE MAN  
SHOULD OWN  
THIS BOOK!**

**THE BIGGEST SELLER  
IN  
RADIO LITERATURE**



**S. GERNSBACK'S  
RADIO  
ENCYCLOPEDIA**

**E**DITED by SIDNEY GERNSBACK, Author of "Wireless Course in Twenty Lessons"—"One Thousand and One Formulas"—"Practical Electricity Course"—"The Radio Educator," etc.

S. GERNSBACK'S RADIO ENCYCLOPEDIA is the only standard work ever published in America attempting to classify alphabetically the countless words used in the highly specialized science of RADIO. The ENCYCLOPEDIA is written in plain English so that everybody can understand the definitions and descriptions.

No expense has been spared, covering over two years in compilation, to make it worthy a place in your library.

It is published in one volume—168 pages—size 9 x 12 inches, over an inch thick and nicely accommodates the beautiful illustrations and the large, easy-to-read type.

The work contains 1,930 definitions, 549 photographs, drawings and diagrams.

**REMEMBER THIS IS A REAL ENCYCLOPEDIA — NOT A DICTIONARY —** and very few of the things described and illustrated in this volume can be found in any dictionary, or any other encyclopedia.

The book contains as a supplement a classified cross index designed to bring together radio references under one heading, having relations in common.

All circuits new and old are described by word and picture and every part and apparatus used in Radio is explained and made understandable by means of photographs and drawings.

The volume is printed upon fine paper—bound in full black Keratol, marbled paper fly leaves and end sheets, with the title stamped in gold.

**SEND NO MONEY**

**Just Pay Postman  
(Canada or Foreign send Check or  
Money Order for \$2.35)**

ISKOR PRESS, Inc., R-10-30  
19 Park Place, New York, N. Y.

Send me one copy of Sidney Gernsback's First Radio Encyclopedia in one volume as advertised. I will pay postman \$2.00 plus postage on delivery.

Name .....  
Address .....  
Town and State .....

it is plugged into the house line, the lamp will light only when the two leads are touched together. Place these two leads on the connector of the eliminator (the part that plugs into the house socket) and, if the bulb lights with anything near normal brilliancy, it indicates that a section of the condenser bank has burned out. The cord should be examined first, however; for a short anywhere across the line will cause the lamp to light. If it lights and the trouble is in the condenser bank, the advanced experimenter will be able to locate the defective section in the following manner. Take the soldering iron and unsolder each condenser lead until the lamp goes out; the

lead just disconnected goes to the burnt-out section. When this is found, merely place a new condenser of two microfarads capacity, in series in this lead. Repairing in this manner saves the necessity of taking out the whole bank. If the circuit of the filter is available, place in this lead the capacity that the circuit calls for; otherwise, use from two to four microfarads (Fig. 3, page 208).

Thus it will be seen, many tests can be made with the degree of accuracy necessary for the home workshop without expensive equipment. By using a little thought the different parts of a radio set and its power supply may be checked quickly, accurately and completely.

## Operating Notes for Service Men

(Continued from page 209)

the former was shorted internally to the latter, causing this high positive bias on one '45, and a low negative bias on the other. In this model, both first and second audio transformers are contained in one case; so that it was necessary to replace the entire unit (Fig. 3, below).

A Service Man may have had the pleasure (?) of endeavoring to subdue oscillation in the Crosley "Gembox" ("Model 609" or "610") which incorporates no balancing or

neutralizing condensers, or other stabilizers. The first step, of course, is to replace all tubes which are below standard. If this does not help, the angles of the radio-frequency coils must be altered; the most critical of the three, and the one most liable to be out of line, is the detector coupler, the first in the front of the set.

When a receiver emits a loud howl in the warming-up process, suspect a gassy '45 power tube, which will require replacement.

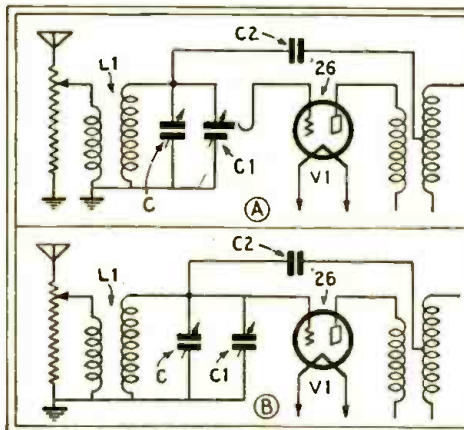

Fig. 1

At the upper left, the peculiar connection of the Philco "Model 87," in which the vernier condenser C1, when turned quite out, acts as a switch to cut out the first R.F. tube. Eliminating this contact, as shown beneath, may cure troublesome hum. At the right, the connections of the double-transformer A.F. unit used in the "Model 846" Stromberg-Carlson.

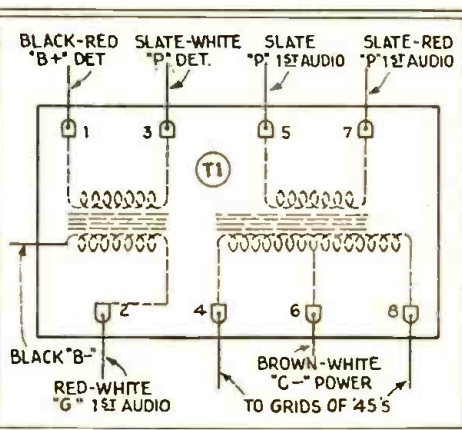

Fig. 3

## What Power Does a Receiver Use?

**W**HEN the question is raised, what current does a receiver draw, it may be answered by actual measurement. This, however, involves a certain amount of trouble. The question, however, comes up when the customer asks about the expense of operation, or when the Service Man is selecting a voltage-regulating device for use between the receiver and the house-lighting receptacle.

A very simple approximation may be found, however, it is pointed out in a recent bulletin of the Clarostat Mfg. Co., by adding up the requirements of the tubes in the set. After making allowances for losses in the power unit and resistors, the requirements of each tube will run as follows:

Type	Watts	Type	Watts	Type	Watts
'12	10	'27	7	'10	17
'71	10	'24	7	'50	45
'26	5	'45	18	'80	15
		'81	15		

For instance, a receiver having three '24s, two '27s and a '45, with an '80 rectifier, thus adds up 68 watts; it is easily taken care of under any load by an automatic voltage regulator rated under 100 watts. Only a set incorporating a '50 tube, or push-pull, is apt to require a larger voltage regulator, of 150-watt rating.

**T**WO new short-wave stations are reported at Sourabaya, Java, operating on 10.51 and 49.70 meters. The calls are PK313 and 3AN.

# The "Stenode Radiostat"

(Continued from page 211)

receiver; response is plotted against frequency. At the bottom, T indicates the signal wave-train, which has been frequency-modulated at an audio frequency indicated by the curve A. The response of the crystal, to this variation in radio frequency, is to pass current in the manner indicated by the curve W. This modified signal is then fed into the grid circuit of the second detector tube, as indicated at the right.

The result is that the presence of the crystal has changed the frequency-modulated waveform of the input into an amplitude-modulated wave W; which is detected in the usual manner and converted into a suitable audio frequency for reproduction.

It will also be seen that, if the frequency of the transmission varies too much, or shifts beyond the points  $f_1$  or  $f_3$ , the station will fade. This would appear to be the case in actual practice. One of the greatest problems of the Stenode Radiostat is to maintain a constant average frequency at the transmitter. Slight shifts in frequency will impair the audio quality. The heterodyne oscillator at the receiving end must be carefully adjusted and maintained constant, in order to keep the intermediate frequency at the proper average value— $f_2$  in Fig. 4. These problems are being, or have been, solved by Dr. Robinson.

### Delicacy of Tuning

The extreme selectivity of this set has made it necessary to incorporate unusual tuning controls. The ordinary type of vernier-dial control is entirely too crude; the slightest touch would tune the station in and out. Therefore, a single-plate condenser has been placed in parallel with the main tuning condenser; and this single-plate condenser is equipped with a slow-motion control, so that one complete turn of the knob varies the capacity only 1 mmf. Even with this delicacy of tuning, a slight turn will pass completely by a station, from silence to silence; for the width of the band passed by the quartz gate is not over 50 cycles—or one two-hundredth of that used in the ordinary broadcast receiver. This extreme selectivity, of course, is due entirely to the quartz crystal, and not to the fact that a superheterodyne circuit is employed. For, if the quartz is removed and a piece of inert material, such as glass, substituted, energy passes through (by virtue of the electrostatic capacity of the electrodes when this capacity is not neutralized); and the set functions as an ordinary superheterodyne, with the degree of selectivity common to superheterodynes.

When the quartz is in place, however, it acts as a gate, allowing only the narrow 20- to 50-cycle band to pass. To prevent capacity coupling through the electrodes, a balanced-bridge circuit is employed. In this bridge circuit the electrode capacity is neutralized by the condenser NC2; so that the only energy that can possibly reach the second detector must pass through the quartz, by piezo-electric action. In Dr. Robinson's laboratory models, an intermediate frequency of 107 kilocycles is employed.

(Continued on page 238)

# NEW YORK Electrical SCHOOL

Day and evening classes open all year. Write or phone for our 64-page illustrated catalog.

Here you learn by doing the actual work. The mind and hands are trained together. This kind of training is never forgotten. Graduates of N. Y. E. S. are years ahead of experienced men in the field, who have not received this special training. Enroll now and start earning good pay in a few months' time.

Special Courses in Automotive Electricity and Mechanics

21 WEST 17th STREET  
NEW YORK CITY

*"Learn by Doing"*



## BEFORE AND AFTER



The Service Man's Visit With



## The Resistor Replacement Guide

With the purchase of 10 Durham Metallized Resistors (until November 15th, 1930) you receive our complete Resistor Replacement Guide free; or you may buy it for 50c.

This remarkable booklet shows clearly and concisely: (1) how to locate cause of trouble in radio sets; (2) proper types and values of resistors to use in all popular types of radio receivers manufactured in years 1927, 1928, 1929. Never before were radio men offered such a complete guide for service work.

Send your order today for 10 resistors—or send 50c—and get this valuable Guide now.

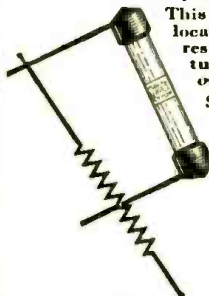

**DURHAM**  
*Metallized*  
**RESISTORS**

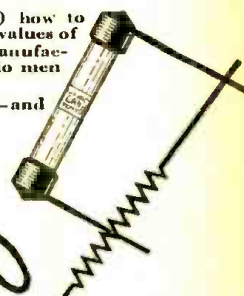

INTERNATIONAL RESISTANCE COMPANY, 2006 Chestnut St., Phila., Pa.  
"No Other Resistor Has All of Metallized's Advantages"

Metallized Resistors are used by the largest radio manufacturers, and more are used by service men than any other make.

## Become a Reporter!



Thousands of opportunities for young men to enter the Newspaper field. Fascinating work. You will meet interesting people; interview celebrities. A famous New York reporter with twenty years of practical experience has written a whole course of journalism and reporting in six easy lessons. He shows you the short-cut to success. He tells you what to do and what not to do, to become a successful reporter. Send today for the "PRACTICAL COURSE IN JOURNALISM," by Henry John Brockmeyer of *The New York Evening Post*. Just drop us a Postal Card—no need to send money. We will mail you the whole set of six books and you pay the Postman \$3.00 plus a few cents for postage. No more to pay. Money absolutely refunded if not satisfied.

PRESS GUILD

16-E Murray Street Dept. A-1030 New York

## Home-Study Business Training

Your opportunity will never be bigger than your preparation. Prepare now and reap the rewards of early success. Free 64 Page Book *Tell How*. Write NOW for book you want, or mail coupon with your name, present position and address in margin today.

- Higher Accountancy
- Modern Salesmanship
- Traffic Management
- Railway Station Mgmt
- Railway Accounting
- Law—Degree of LL.B.
- Commercial Law
- Industrial Management
- Banking and Finance
- Telegraphy
- Business Management
- Business Correspondence
- Credit and Collection Correspondence
- Modern Foremanship
- Personnel Management
- Expert Bookkeeping
- C. P. A. Coaching
- Business English
- Commercial Spanish
- Effective Speaking
- Stenotypy—Stenography

LaSalle Extension University, Dept 10303-R Chicago

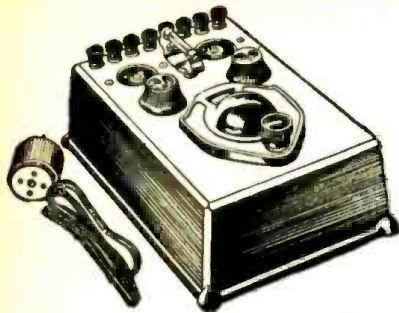

SHOWING No. '01 ADAPTER PLUG FLEXI-UNIT  
EXCLUSIVE FEATURES

(Possessed By No Other Device on the Market)

Efficient reception of the entire wave band of 15 to 550 meters with four silk insulated plug-in coils.

An attractive Aluminum Cast Shield of one-eighth inch thickness to insure against body or hand capacity.

Unit may be used with either A.C. or Battery receivers, or as an individual single tube receiver for short or long waves.

Unique antenna connection arrangement insures freedom of oscillation at all frequencies without dead spots.

Serves many purposes. Indestructible! Simple to operate — and inexpensive.

WRITE FOR FREE LITERATURE

One of America's Pioneer Radio Manufacturers

THE WORKRITE RADIO CORP. - 1808 E. 30th St., Cleveland, Ohio

## George W. Walker FLEXI-UNIT

*A Flexible Radio Device of  
Unlimited Application*

SHORT WAVE RECEIVER  
SHORT WAVE ADAPTER  
REGULAR BROADCAST TUNER  
R.F. PRE-AMPLIFIER (BOOSTER)  
RADIO "EXPERIMENTAL" UNIT  
OSCILLATOR WAVE TRAP

Use this unit ahead of your Short  
Wave Tuner as a R.F. Booster

Should your dealer be  
unable to serve you  
promptly — mail your  
order direct to factory.

List Price  
**\$16.<sup>00</sup>**

Including Coils

No. '01—Adapter Plug (Battery).....\$2.00  
No. '27—Detector Plug (A.C. Sets)..... 2.50  
No. '27—R.F. Adapter Plug (A.C. Set).. 3.00

# FREE

for your  
promptness!

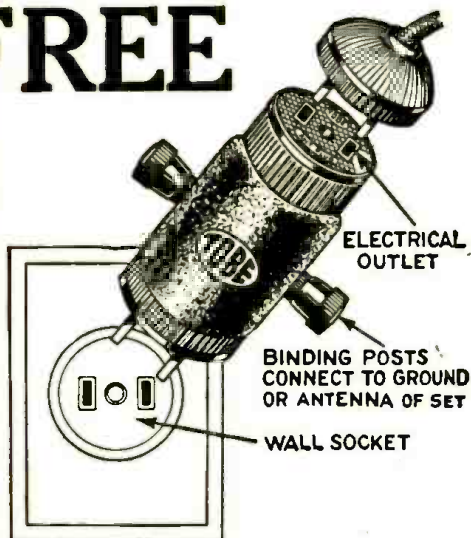

Mail this  
Coupon **TODAY!**

**A** TOBE 4-Way Purpose  
Light Socket Aerial with  
every radio convenience  
in one small unit—and given  
to you free with one year's  
subscription to RADIO-  
CRAFT.

This unit serves as a perfect  
indoor antenna, reduces static  
pick-up, and gives clear, pure  
tone reception, or—

A convenient and efficient  
ground without troublesome  
water-pipe connections or long  
wires, and—

A power-socket outlet which  
may be used for operating set,  
"B" eliminator, power pack,  
charger or any electrical ap-  
paratus, and—

A lightning arrester, protect-  
ing the set from all high-poten-  
tial atmospheric discharges.

The most convenient of all  
radio antenna developments.  
TOBE SOCKET AERIAL is  
sold with a two-year guarantee.  
Complete instructions showing  
many combinations included  
with each aerial.

RADIO-CRAFT, Dept. E  
98 Park Place, New York, N. Y.

I have enclosed \$2.50 for a year's subscription  
to RADIO-CRAFT. Please send me FREE  
Tobe 4-Way Light Socket Aerial.

Name .....

Address .....

City..... State.....

### ALUMINUM BOX SHIELDS

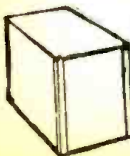

Beautiful silver dip finish, 5 x 9 x 6  
inches, \$1.89; 6 x 14 x 3 inches, chassis,  
\$3.45. We make any size to order in  
24 hours.

Hammarlund Equalizers EC35, 35¢;  
Braidite Wire, 25 ft., 20¢; EX STAYS  
for your Auto Radio; 2-volt tubes;  
Shielded Choke Coll., 45¢; .01 Mica  
Condenser, 35¢.

BLAN, The Radio Man, Inc.  
89K Cortlandt St., New York, N. Y.

Write for Information about the NEW

### H-F-L MASTERTONE

LABORATORY MADE RECEIVER

The Year's Outstanding  
Radio Achievement

HIGH FREQUENCY LABORATORIES

3900 N. Claremont Dept. 81 Chicago, Ill.

## The "Stenode Radiostat"

(Continued from page 237)

Waves Doubly Modulated

It is evident that the ordinary, broadly-tuned receiving set will not give reproduction when tuned in to a frequency-modulated station. But the question is, will the Stenode receive an amplitude-modulated station? Theoretically, no. But tests prove otherwise, and we are interested in facts. These show that, in the modern amplitude-modulated station, a slight frequency-modulation also exists. And this slight frequency-modulation is sufficient to actuate the Stenode. The test, however, would not prove that sidebands are not necessary.

One of the main points of this article is to show that the results obtained with the Stenode Radiostat fail to prove that sidebands do not exist or are unnecessary. It is true that the Stenode receives ordinary stations with a great degree of success—and it receives those stations whose frequency is controlled by quartz crystals much better than the others, which fade, or are hard to tune in. What the tests do prove is that the ordinary type of station, even though quartz-crystal controlled, is frequency-modulated as well as amplitude-modulated. The slight frequency-modulation which exists is due, probably, to some unexplained circuit conditions.

The amplitude-modulated component of the wave could be entirely eliminated; its existence is detrimental, since it causes the low notes to be disproportionately amplified; since the quartz circuit is one of low damping and the persistence of the lower notes is considerable. Hence, a special filter is used in the Stenode's audio amplifier to compensate for this low-note frequency distortion.

How about sidebands when using a frequency-modulated transmitter? Primarily, we radiate waves ranging in frequencies from  $f_1$  to  $f_3$ , (Fig. 4) a difference of 20 to 50 cycles. This band of waves we know to exist. But, since changing the wave-shape adds sidebands, or harmonics, as stated previously, other frequencies may be introduced. To what extent, if any, these widen the band is a problem for the mathematicians. Dr. Robinson's tests indicate that the effect must be negligible. At least, the improvement over the old method is enough to allow some hundred times as many stations to transmit at the same time without interference.

How soon the system will be placed in commercial use, is difficult to predict. It would necessitate revolutionary changes in all receiving sets, as well as transmitters, and the expense would be enormous. Television, which requires the greatest space in the ether, may be the first to benefit by this system.

## Television Progress

(Continued from page 213)

of a radial slit over a spiral slit may be made of any size suited to the image being received. The spiral discs turn once while each frame of the image is being scanned; the radial discs are rotated by a separate shaft, at a speed sufficient to provide the necessary number of lines in each frame.

For instance, in the case of the German and



English transmissions, the spiral discs revolve  $12\frac{1}{2}$  times a second; but since the number of lines in the received images is 375, the 20-line radial discs must turn at the rate of  $18\frac{3}{4}$  times a second, or 1125 R.P.M. The width of the slots is, necessarily, related to the number of lines in the image: the more lines, the finer the slots must be.

In the Fries system, it is necessary to synchronize the two parts of the scanning system with each other, as well as with the transmitter. The simplest method of coupling the pairs of discs is by gears; but this would necessitate frequent gear shifting. For that reason, two electric motors are connected to vacuum-tube generators which modulate each other. As will be seen, a good deal of complexity is bound up in the operation of this device which, however, demonstrates a solution of the problem of universal television.

OPTICAL REGENERATION

In the endeavor to overcome the difficulties caused by the low available light intensities, in practical television, Col. Schildenfeld, an Austrian inventor, has patented the idea of applying regeneration to a photocell system. It is well known that the amount of light required for successful television is often rather trying to the subjects and, outside of laboratories, it is seldom available. By this invention, the light impulses are caused to modulate a light source which shines directly back into the photoelectric cell.

Many practical difficulties, of course, are yet to be solved, including those of time-lag and possible optical "oscillation." The idea is especially well suited to oscillograph work; but it is being tested for its possibilities in television.

—Radiowelt (Vienna).

## Men Who Have Made Radio— Count Georg von Arco

(Continued from page 213)

the Telefunken Company. (The name is coined from the German word *Funk*, or "spark," which, from the type of radio transmitters originally used, has become the term for radio of all descriptions). Count Arco was selected as its manager and technical director upon its institution in 1903; and his whole strenuous personality has been since continuously devoted to its development. No great organization has ever been more truly "the lengthened shadow of a man."

The Slaby-Arco system of wireless, then competing for favor in the markets of the world, utilized an aerial so connected across its spark coil that the unbalancing of the system produced radiation; the receiver comprised a coherer (then the only practical means of detector) with a loading coil grounded at both ends. Inefficient as the arrangement was, in the light of modern practice, it had great merit compared with others; and in 1903 the United States Navy, as a result of its tests, installed Slaby-Arco equipment. In this year, too, the necessity for intercommunication among vessels on which wireless equipment of different competing systems had been installed, forced the calling of the first international radio conference, in which Arco was among the leaders.

The accomplishment which has always remained closest to his heart is the erection of the great station at Nauen, with its almost numberless transmitters, to accomplish direct communication from Germany to the most distant points of the world. The Telefunken system of radio, in ship and shore stations, continued to expand, however, in a field of the most intense competition stimulated by different national interest; in 1905 it had 518 radio stations, and in 1909 it led the world decisively in the number of installations.

Technical improvements succeeded in bewildering rapidity. Between 1903 and 1928, it is stated, Arco himself filed 370 patent applications. Yet his distinguishing characteristic, which has impressed itself upon his associates, is the intuitive ability to grasp the possibilities of new ideas and to exploit them

without regard to the mortality among his former brain-children. He used each new development forcefully; in 1906 the advantages of continuous-wave operation were revealed, and in that year he demonstrated radio telephony over a distance of more than twenty miles. In that era, antedating the vacuum-tube, his most ingenious efforts were turned to the development of high-frequency machine generators, increasing the range of transmissions. The great American station at Sayville, Long Island, was erected in 1912 to work with Nauen, and in 1913 its spark system was replaced by high-frequency generators.

The war came, and put its terrific pressure upon German resources and German ingenuity; at its catastrophic close there lay before Arco the task of building up again under tremendous handicaps, the great communication system he had fathered. He turned to short waves; and their commercial success as well as technical is shown in the multiplication of radio links which unite Nauen to transmitters in America and Asia; until, a few days ago, the Orient and the Occident conversed by way of the central station as if it were a local telephone exchange.

The possibilities also of the vacuum tube were quickly grasped by Arco, and led to the organization of the German tube industry, using his inventions. A little touch of human interest is conveyed in the fact that his name has been given to the latest tube produced—the "Arcotron"—of unique design and intended to facilitate the production of very economical receivers for use in Europe and other countries, where the crystal alone has been hitherto within the means of many listeners.

Energetic and in full vigor, Count Arco still devotes the spare moments wrung from an exacting round of duty to radio as a hobby and to its popularization among his countrymen. A genial, impulsive and forceful personality, his character is summarized in the oft-quoted motto "*Dienst am Werke*" (Service by Deeds).

### KEEP STEP WITH RADIO PROGRESS!



RADIO is one of the real marvels of this modern age. The demand is for technically trained men — men who keep pace with the unfolding revelations of this mighty and promising industry.

The International Correspondence Schools Course in Radio, prepared and constantly supplemented by outstanding authorities in the field, is specifically designed to meet the requirements of the radio industry for technically trained radio men.

Authorities responsible for the preparation of the I.C.S. Radio Course include: H. H. Beverage, Radio Corporation of America; George C. Crom, American Transformer Company; Keith Henney, author of "Principles of Radio"; Malcom E. Gager, instructor at the Massachusetts Institute of Technology; E. V. Amy, consulting radio engineer, formerly with R.C.A.; H. F. Dart, authority on radio tubes; Julius C. Aceves, consulting radio engineer, formerly of Columbia University, and others.

The I.C.S. Radio Course is complete, from the foundational principles of radio to the most advanced stages. It also outlines the principles and possibilities of television.

Mark and mail the coupon. We will send you all details. This act may be the real beginning of your career in radio!

INTERNATIONAL CORRESPONDENCE SCHOOLS  
Box 6675, Scranton, Pa.  
Without cost or obligation, please tell me all about the  
NEW RADIO COURSE

Name \_\_\_\_\_  
Street Address \_\_\_\_\_  
City \_\_\_\_\_ State \_\_\_\_\_  
If you reside in Canada, send this coupon to the International  
Correspondence Schools Canadian, Ltd., Montreal, Canada



## PATENTS TRADE-MARKS

DO NOT LOSE YOUR RIGHTS  
TO PATENT PROTECTION

Before disclosing your invention to anyone send for blank form "EVIDENCE OF CONCEPTION" to be signed and witnessed.

**LANCASTER, ALLWINE & ROMMEL**  
(Registered Patent Attorneys)  
475 Ourray Bldg., Washington, D. C.  
Originators of forms "Evidence of Conception"

# SERVICE MEN!

Here's a  
**Money Maker**

and a life saver for tubes and sets. You can add many dollars to your weekly pay envelope if you will carry a supply of the

~~Automatic~~ Line Voltage Regulator  
**CLAROSTAT**



It is really an automatic ballast or self-compensating type of resistor offering high resistance to high line voltages and low resistance to normal or below normal line voltages.

It fills a much needed want for the Big Army of Radio Set Users. Easy to attach—just plug in the socket.

Send for free circular.

Type "A"—For sets consuming 100 watts or less  
Type "B"—For sets consuming 100 to 150 watts

**\$1.75**

CLAROSTAT MFG. CO., INC.  
295 North Sixth St., Brooklyn, N. Y.

**DEALERS AND  
SERVICEMEN**

**Radio Bargain News**  
BUY FOR CASH AND SAVE HALF  
Write for Your FREE Copy of this BIG Catalog 40 PAGES OVER 1,000 ITEMS OF REPLACEMENT PARTS FOR ALL STANDARD SETS  
Free Write Now  
FEDERATED PURCHASER  
22A Hudson Street  
New York, N. Y.

Make sure your  
**Resistors are Right**

Specify:—  
**RESISTORS of  
"NICHROME"**

Made by  
**DRIVER-HARRIS COMPANY**  
HARRISON, N. J.

# Resistor Replacement Rejuvenates Old Sets

By FRANCIS R. EHLE\*

IN the automobile business there are two broad methods of selling a trade-in: first, as frequently practiced in rural communities, the car is left "as is," until a purchaser comes along and takes it at his own figure; or, secondly, the car is turned over to the mechanic, who proceeds to tune it up to the point where it will bring a fair price. In radio, the situation can be made just about the same: the radio trade-in may be disposed of for \$5.00 or \$10.00, "as is"; or it may be slightly tuned up, at little expense, commanding a fair price and actually creating good will rather than bad feeling on the part of its purchaser.

Today, there are too many sets allowed to go to rack and ruin for want of very simple and inexpensive attention. In the back rooms of many dealers throughout the country are to be found tens of thousands of radio sets, most of them of the battery vintage, begging for buyers. Such sets bring only about \$5.00 each, as they stand; because their sensitivity and selectivity are questionable factors, even to those seeking bargains. However, if such sets were given a slight overhauling, they might readily fetch \$15.00 to \$25.00, based on their performance during a demonstration or trial. It so happens that many owners of the latest A.C. sets are anxious to own a second and even third set, for use in some other part of the home, on the farm, in the summer home, on the motor boat and elsewhere.

According to the findings of our engineering staff the usual trade-in set has much useful life remaining in it, if properly exploited. Such items as inductances, tuning condensers, fixed condensers, mechanical components and sockets are little the worse from wear and age. However, the least-suspected items, namely, the fixed resistors, frequently are worn out and cause a marked decrease in sensitivity and selectivity. Most components of a set either function or break down. The usual resistor, however, is far more deceptive; since it continues to function, even though its characteristics have changed to the extent of rendering it useless for the task originally intended. The altered resistance value may be attributed to the fact that several years ago, when the usual trade-in radio set was made, resistors were not thoroughly seasoned as at present, and therefore were apt to change in resistance value over a period of time. Actual measurements, made on resistors found in sets of pre-A.C. vintage, indicate an increase or decrease of the resistance value which is obviously sufficient to throw the operation far out of gear.

A few years ago, also, many experimental types of resistors found their way into production set. The resistive material in many instances broke down in actual service, resulting in much noise due to faulty conduction.

The inexpensive replacement of the few resistors in the average radio trade-in is certain to work wonders in the operation

of that set. Reliable metallized resistors are standard today, and resuscitate the set which must otherwise be sold for almost nothing, or broken up for its components which are of little value. A few resistors and an hour's time makes all the difference between trade-ins sold at a loss of money and good will, and a new source of immediate and future profits.

# Short-Wave Craft The Superheterodyne

(Continued from page 215)

such as the '12A, is needed; it should also be of low impedance, like the '12A, in order that it may work well with modern transformers. For the '12A, a 7-meg. leak and a .0002-mf. grid condenser will be an entirely satisfactory compromise for good quality and medium sensitivity. This detector, ordinarily, will require a good two-stage A.F. amplifier, with the last stage push-pull. With the '12A detector at full load, enough voltage will be developed for the grids of the power tubes—about 27 volts, to run two '71A's, with rated "C" bias and 135 volts on the plates; at full undistorted output. If greater undistorted output is required, it must be obtained by suitable design of the amplifier equipment following the second detector.

But the short-wave telegrapher, interested entirely in communication, has not accomplished his purpose until sensitivity and selectivity practically guarantee contact with other stations; but without regard to tone (in fact, a certain amount of distortion may actually be an aid). His first consideration being sensitivity, he will need the high- $\mu$  '40-type tube, which permits a detector gain as high as 60 to 90. This tube, of course, has an impedance too high to permit suitable transfer of the lower bass notes; but he has no need of them and, consequently, may use A.F. transformer coupling. Incidentally, when this tube is used with a 4-meg. leak and a .0002-mf. grid condenser, it does not introduce sufficient distortion to limit voice communication appreciably; being in this respect superior to the line telephone to which we are accustomed. Consequently, the amateur's radiophone work is aided, not impaired, by the increased sensitivity, even though the tone is somewhat affected.

Now, if you folk "out there" want to know more about this romantic, intriguing, inspirational, educational and superlative radio circuit, the superheterodyne, (which includes in its design practically every engineering detail in radio reception), sit right down and dash off a couple of lines telling us just how this story appealed to you; let us know what you would like future articles on this subject to explain for your benefit; and suggest future material on this topic.

\* President, International Resistance Co.

# A Two-Volt Screen-Grid Receiver

(Continued from page 221)

hook-up wiring below the deck will greatly improve appearances. When completed, the chassis is fastened to its shelf with three angle brackets.

The loop, which is wound on wooden pegs inside each corner of the hinged front cover, will require about 60 feet of stranded wire; it is then covered by thin wooden strips to protect it from injury. The two binding posts for its ends are mounted on a thin strip of bakelite. The leads must be brought to the jack (3A) for connection into the circuit.

### List of Parts

- Two Hammarlund "Midline" two-gang condensers, .00035-mf., type "MDK-35" (4-10, 16-23);
- One Silver-Marshall drum dial, type "810-R" (15A);
- Four Hammarlund equalizer condensers, 35-mmf., type "EC-35" (5, 11, 17, 24);
- Four Silver-Marshall shielded R.F. coils, "No. 121" (3, 9, 15, 21);
- One Silver-Marshall R.F. choke, type "275" (28);
- Six Polymet "Hi-Volt" condensers: three 0.25-mf., type "C-902" (6, 12, 18); two 0.5-mf., type "C-903" (41, 42); one 1-mf., type "C-904," (22);
- One Thordarson A.F. choke, type "R-196," (29);
- One Electrad "Truvolt" 15,000-ohm resistor, type "B-150" (39);
- One Electrad "Royalty" 20,000-ohm variable potentiometer, type "H," with filament switch (39-45);
- Five Eby UX sockets;
- Four Eby engraved binding posts (1, 2, 34, 35);
- One Electrad closed-circuit jack (3A);
- One Electrad 250,000-ohm metallic resistor (31);
- Two small molded bakelite condensers; one .001-mf. (27); one .006-mf. (30);
- Five Amperites; with mountings; four No. 5V-99 (8, 14, 20, 26); one "No. 120" (33);
- One roll "Corwico Braidite" solid-core hook-up wire;
- One "Corwico" six-wire battery cable, type "230-A" (36, 37, 38, 43, 44, 46);
- One can Kester rosin-core solder;
- One Aluminum chassis, 6 x 14 x 3 inches;
- Five National Union tubes; four NX-232 (7, 13, 19, 25); one NX-231 (32).

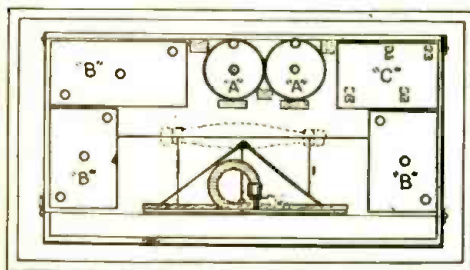

Fig. 3

The arrangement of the speaker and batteries in the lower compartment of the portable case. The chassis shown in Fig. 2 is supported on a shelf above them; and the whole covered by a plywood panel, and the hinged cover-loop.

### Parts for Case

- Two pieces 3-ply (3/16-in.) wood; 15-in. x 16 $\frac{3}{8}$ -in. for panel; 15-in. x 16 $\frac{7}{8}$ -in. for front cover;
- Nine pieces of white wood,  $\frac{1}{4}$ -in. thick; two 16 $\frac{3}{8}$ -in. x 6 13/16-in. for sides; two 15-in. x 7 $\frac{1}{4}$ -in. for top and bottom; one 15-in. x 16 $\frac{3}{8}$ -in. for back; one 14 $\frac{3}{4}$ -in. x 6 13/16-in. for shelf; two 15-in. x 13/16-in. for top and bottom of cover; two 16 $\frac{3}{8}$ -in. x 13/16-in. for side of cover.
- One leather strap for handle;
- Hinges for cover and back;
- One spool "Corwico" D.S.C. litz wire,  $\frac{1}{4}$ -pound, 32-strand No. 38, for loop;
- One Amplion 7-in. magnetic cone speaker, automotive type, "Model GW";
- Two 1 $\frac{1}{2}$ -volt dry cells;
- Three 45-volt "B" batteries, compact portable type;
- One 22 $\frac{1}{2}$ -volt "C" battery, tapped;
- One roll "Corwico Echo Tape" for aerial wire.

## Radio's Greatest Debt

RADIO, with all of its magic, is not different from other industries. Buy a radio receiver as you would buy an automobile, or any other staple item. Do not be stampeded. If you are satisfied with what you have, why purchase a new receiver? But if your automobile is old and rattly, you do not blame the roads; you get a new car when you can afford it. By the same token, if your radio is out of date, do not blame the quality of the broadcast station. Then is the time to get a new radio, that you may take advantage of all that your broadcast station is transmitting.

When a phonograph or a player piano or a home-movie projector is purchased, they are useless unless material in the form of records or films is purchased or rented to go with them. When a radio receiver is installed, the program is forever varied and free. No part of this entertainment cost is added to the receiver price, nor is it obtained through taxation. While there may be an occasional objector to the sponsored program method in use in this country, there are few who fail to recognize that the quality and the quantity of the American programs are vastly superior to those of countries where the tax method of radio support is in vogue.

We manufacturers of the radio industry who are so dependent on the maintenance of good broadcasting have made a most thorough study of this important subject. We naturally desire to see that the very best in broadcasting is made available. Our conclusion is overwhelming that the radio manufacturing industry, as well as the listening public, owes a tremendous debt of gratitude to the broadcast stations and to the broadcast systems of this country.

(From an address by H. B. Richmond, retiring president of the Radio Manufacturers Association, broadcast from Atlantic City.)

## The New Protecto Voltage Regulator



THIS new, and wonderfully improved, PROTECTO Voltage Regulator, automatically regulates the fluctuation in the A.C. or D.C. flow of current that reaches the radio set. A uniform current flow greatly improves reception, and assuredly prevents tubes from blowing out because of excess line voltage.

Inexpensive and thoroughly practical, every Service Man and Dealer should be equipped with a large supply—ready to recommend to his trade.

If your dealer cannot supply you, we will be pleased to fill your order.

PROTECTO MANUFACTURING CO.

1157 Flatbush Ave., Brooklyn, N. Y.

**RADIO Isn't Modern Without Automatic VOLTAGE CONTROL**

See that the electric radio you buy or build is equipped for the **AMPERITE Self-Adjusting LINE VOLTAGE CONTROL**. Prevents noisy voltage fluctuations. Improves Reception—Saves Tubes.

Write for Useful Bulletin. Address Dept. RC-10

**AMPERITE Corporation**  
561 BROADWAY, NEW YORK

**AMPERITE**  
Self-Adjusting  
LINE VOLTAGE CONTROL

**FREE! RADIO BARGAIN CATALOG**

**ALSO FREE RADIO GIFT**

Send now for this new free radio catalog which saves you many dollars on radio outfits, kits, parts, tubes and accessories! Also **TIME CONVERSION CHART FREE**. Tells you instantly what time it is in any part of the world! Given free if your request for catalog reaches us this month.

**20th CENTURY MAIL ORDER CORP.**  
202 JACKSON ST., CHICAGO, ILL.

Genuine **PILOT** Products

# HOTEL DIRECTORY OF THE RADIO TRADE

The hotels on this and the following pages are patronized by the Radio Trade. Make them your headquarters.

*New Hotel*  
**LA SALLE**  
 WOODWARD at ADELAIDE  
**750 ROOMS**  
 EACH WITH BATH  
 \$2<sup>50</sup> to \$4 a day Single  
 \$4 and up Double  
 IN THE CENTER OF  
**DETROIT**

LA SALLE  
 GRILL  
 for  
 QUALITY  
 FOOD



*The* **Belvedere**  
 FORTY EIGHTH STREET  
 WEST of BROADWAY  
*New York*

Resident and Transient

450 OUTSIDE ROOMS  
 Each With Bath and Shower  
 Serving Pantry

\$3 to \$6 PER DAY  
 Special Weekly or  
 Monthly Rates  
 Best Food in New York

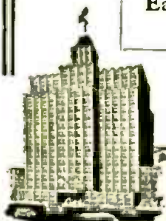

D. M. PEPPER  
 MANAGING DIRECTOR

## The "Universal" Receiver

(Continued from page 217)

wire, except for L9, in which No. 30 enamelled is used. Windings are separated 1/4-inch except for L5, in which the separation is 1/8-inch. The number of turns, and the bands covered, are as follows:

Coil No.	Coupler Turns	Tickler Turns	Band Meters
L5	3 1/2	4 1/2	10-28
L6	6	6	28-40
L7	9	7	40-60
L8	12	8	50-90
L9	25	13	95-195

While the reader might think that losses would be reduced, and efficiency gained, by placing the grid terminals of these coils away from the shields, the writer gives the advice, based on experience, that the grid ends be turned toward the aluminum plate on which the coils are mounted. The ticklers are wound beside the couplers, at one end, with the same spacing and in the same direction. The outer ends of the windings connect to the plates of their respective tubes, V10 and V9.

### An Operating Peculiarity

The following phenomenon is offered to short-wave experimenters for further investigation: when the blade of Sw5 is placed between two contacts, so that it shorts the coupler windings, and that of Sw6 is placed on the tickler contact of the longer-wave coil, signals on a wave about three-fourths as high as that of the shorter coil are brought in with volume greatly increased in comparison with that obtained on the regular coil.

Of course, the resonant wavelength of two coils in parallel is less than that of either alone; but something more than this is required to explain the great increase of volume that is obtained by this method of shunting.

For long-wave operation, both dials are adjusted together; the right dial controls the tuning of the antenna circuit independently. This shaft carries also the short-wave tuning condenser C20, and is the only tuning control used for short-wave work. The regeneration condenser C21 is controlled by a knob.

With this receiver coupled to a Jenkins televisor, very satisfactory silhouette reproductions have been obtained on the short waves.

### FEATHERED RADIO CRITICS

WHEN the forestry movement was new, the story was told of a man who was called on suddenly to tell what he had done to save our country's resources, and explained that he had shot woodpeckers. The same method is now suggested for radio fans.

A Pennsylvania broadcast station which used wooden masts was put out of commission, some time ago, by the snapping off of one huge cedar pole, nearly three feet thick and a hundred feet high. The failure was found to be due to industrious woodpeckers, who had been attracted, it is thought, by the singing of the aerial.

## Radio-Craft Kinks

(Continued from page 220)

the fact that there are two local stations (in Baltimore, Maryland) which could be tuned in on his aerial by using a small coil with no condenser. After trying out several substances, it was found that a jackknife would serve as a crystal and a common pin for a catwhisker, with surprisingly loud signals in the phones. The simple layout is shown in Fig. 7.

The coil is but 15 turns of wire on a 3-inch tube, directly in the antenna circuit, and shunted by the phones in series with the jackknife-pin detector.

(It will be realized, of course, that there is nothing here to give detection except a high-resistance metallic contact—like those used in the early days of wireless before the crystal and the tube had been invented. It will not be a sensitive combination, but in the electrostatic field of a local station reception may be obtained when exactly the right degree of contact is obtained.—*Editor.*)

### CLEANING OLD TUBE BASES

By George F. Schreiber

**F**OR the winding form use a tube base." With this injunction in his ears, the radio fan rolls up his sleeves and reaches one hand toward a derelict tube and the other toward a hammer; possible result, cut fingers. On the other hand, the blow-torch method will probably result in a charred and useless base, after a vigorous effort to remove excess glass and cement.

Instead, try boiling the tube in a pan of water for about five minutes; it may then be removed from the base by continued turning in one direction. (First wrap the tube with cloth). While the base is still hot, the cement may be removed readily with a knife.

This method of removing cement is much quicker than that more generally practiced, of filling the base with alcohol and waiting for the alcohol to take effect.

With a small soldering iron (the writer's preference is the automatic blow torch, which leaves both hands free) melt the solder at the ends of the prongs; and then pull out the leads with a pair of pliers.

## Running Your Radio on "Nothing"

(Continued from page 222)

five-volt, quarter-amp. tubes, requiring a total of 1.75 amps. at (since the set has in it filament ballasts) 6 volts. Looking at the Lamp Table we see that 7x31.5 watts, or 220.5-watt lamp-rating is required. The wattage used, in fact, is 220, consisting of one 100, and two 60-watt lamps in parallel. With the line-voltage running consistently at 130 volts, the "A" voltage with R3 all out is 6.3 volts; with R4 barely in, as shown in Fig. 1, voltage is 5.5.

You will note that two quarter-henry, 2-amp. chokes in series are used. One is sufficient for sets of medium sensitivity; but for the modern highly sensitive set with three or more stages of radio-frequency amplification two chokes are indispensable for first-class results, as they are also for short-wave work. Before and after the chokes are the

## Hotel Directory of the Radio Trade



**\$3.00**  
Per Day  
and Up

**800**  
Rooms  
800 Baths

*Old Fashioned Hospitality  
in a Modern Setting*

In the Grand Central Section, 10 minutes from Penn. Station, near Times Square, Fifth Avenue shops and important commercial centres and theatres.

*Radio in Every Room*

Single Rooms \$3 to \$5 per day  
Double Rooms \$4 to \$6 per day

S. Gregory Taylor, *President* Oscar W. Richards, *Manager*

**HOTEL MONTCLAIR**  
42<sup>ND</sup> TO 50<sup>TH</sup> STS.  
AND LEXINGTON AVE.  
**NEW YORK CITY**

## Hotel Dixie

**42<sup>d</sup>-43<sup>d</sup> Streets West of Broadway**

*A New and Better Hotel for Times Square*

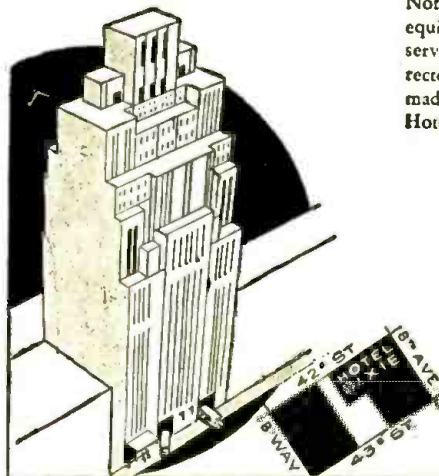

Not alone new in construction and equipment, but new in conception of service and comfort to its guests. Directed by S. Gregory Taylor, who has made such enviable successes of the Hotels Montclair and Buckingham.

**Single Rooms**  
with tub and shower

**\$3, \$4 and \$5**

**Double Rooms**  
with tub and shower

**\$4, \$5 and \$6**

A few terraced rooms and suites, exceptionally large closets, on an attractive monthly basis.

**RADIO IN EVERY ROOM**

Entrances on 42nd and 43rd Sts.

**CENTRAL UNION BUS TERMINAL**

LOCATED IN THE DIXIE HOTEL BUS CONNECTIONS FOR ALL POINTS IN THE UNITED STATES

# HOTEL DIRECTORY OF THE RADIO TRADE

*Chicago's Newest Hotels*



**The St. Clair**  
500 Rooms—\$2.50 up

**Hotel Eastgate**  
Ontario Street, one block East of Michigan  
*Excellent cuisine, and service perfect to the smallest detail*  
*Just a Step from the Loop*

**FREE GARAGE**  
NO INCREASE IN RATES

Free Garage to tourists

**St. Clair Hotel**  
Ohio and St. Clair Streets  
Telephone: Superior 4660  
Beautiful Dining Room - Coffee Shop - Service Ultra Mode



**The Eastgate**  
300 Rooms—\$2.50 up

condensers C1 and C2, which are the recently marketed dry-electrolytic condensers of large capacity. (A note of caution should be added: after once putting these condensers in service, do not change the polarity of their terminals.)

In the "A" side of the pack is placed also a 30-ohm rheostat (R4) which is used only if the wattage of the lamps employed as resistance is greater than needed; in which case, in conjunction with the relay L5, it passes the current not needed by the tubes. The relay has an additional function, that of protecting the "A" condensers C1 and C2 from excessive voltage—quite an important matter, since they are designed only for low potentials, up to about twelve volts. The relay performs this task by shunting excess current through the rheostat R4 when the set is in use and, when it is turned off, through the resistor R5. If, for example, your receiver has a panel switch in the positive filament lead (which you would not ordinarily switch off at all, since you would use S2), and suppose the maid shut it off in dusting, when you turned on S2 the current would find a path through R5, rather than by breaking down the condensers C1 and C2.

### Use of a "C" Unit

The last part of the circuit to be considered is that concerned with obtaining grid bias from the line supply. This is done by passing the current from the filaments of the tubes, plus that from their plates, through a heavy-duty rheostat, R3, by-passed by condenser C7, which has a capacity of 1-mf. Several statements must be made about obtaining grid bias in this way. The first is that the "C" bias reduces the effect of surges and ripple only in those tubes that are normally biased negatively, and then only if the phase relations between tubes are right. A helpful discussion of this problem by Victor L. Osgood was published in the *New York Sun* Radio Section on June 9, 1928.

The second point is that, in all sets having a positively-biased detector (and that is most of them) and in all sets with radio-frequency amplifier grids at zero potential, or controlled by a potentiometer, the "C" bias from the line hinders rather than helps the suppression of ripple and line-surges; for the reason that the grid potentials of those tubes are higher than ground by the amount of bias taken from the line for the power tube and, in the case of the detector, by its filament voltage in addition. Hence, surges and ripple get on the grids directly.

In general, then, it is better to omit the grid-bias provision made in this pack; although it is valuable if you don't object to a little ripple, or if you have a set with all tubes biased negatively, and with phase relations right between tubes.

### Measure the Input

In constructing this pack, the usual precautions are necessary: ground (to "A—") the cases of all condensers and cores of all chokes; use heavy rubber-covered wire (No. 14 or 16) for "A" connections and connections to the line; insulate every connection with electrician's tape; and, if you want the best results, shield everything in sight!



**The MADISON**  
ILLINOIS AVENUE  
Overlooking Boardwalk and Ocean

"A Hotel Distinctively Different"  
JUST COMPLETED IN  
**Atlantic City**  
Unexcelled Colonial Hospitality

Now Ready for YOU  
Fireproof — Showers and Baths Throughout

From \$4.00 daily European Plan  
From \$7.00 daily American Plan

FETTER & HOLLINGER, INC.  
Eugene C. Fetter  
Managing Director

Reduced Rates at  
**CLEVELAND'S**  
*Newest*  
**HOTEL**

**AUDITORIUM**

EVERY ROOM WITH BATH

\$2  
\$2.50  
\$3

300 Clean Modern Rooms



East Sixth St. & St. Clair Ave.  
W. H. BYRON, Manager

You had best measure accurately your line-voltage before taking too implicitly the table of lamps as a guide. The table is figured on the basis of 120 volts; but in fact the line-voltage may run from a little less than 110 to 130 or slightly more, depending on your distance from the generators, the load on the line, etc. If your line is less than 120, the wattage of the lamps will need to be slightly higher; and, conversely, if you have, as the writer does, 130, the lamp sizes, after your electrolytic condensers are fully formed, will need to be slightly less than those given. This applies particularly if you are supplying 1.1- or 3.3-volt tubes. Start with a small wattage, work up to that which you need, and be safe rather than sorry!

**RESISTANCE REQUIRED**

In Series with Receiving-Tube Filaments  
6-Volt Output

Filament Current Amperes	Line-Voltage 110	Line-Voltage 120
1.00	103 Ohms	113 Ohms
1.25	83 "	90 "
1.50	69 "	75 "
1.75	59 "	65 "
2.00	51 "	56 "
2.50	41 "	45 "
3.00	34 "	38 "
<b>4.5-Volt Output</b>		
0.18	583 "	639 "
0.25	420 "	460 "
0.36	292 "	319 "
0.42	250 "	274 "
0.48	219 "	240 "
0.54	194 "	213 "
<b>1.5-Volt Output</b>		
0.5	216 "	236 "
0.75	144 "	157 "
1.00	108 "	118 "

Note: The Ward-Leonard type-507 resistances with Edison bases, which screw into the ordinary lamp sockets, are convenient and, by putting several in series or in parallel, as required, can be combined to give, within an ohm or two, any resistance specified. They come in various resistances with varying current capacity.

**Table of Lamps Required**

Type of tube	Lamp wattage per tube
5 v., 0.25 amp. (201A, 112A)....	31.50
5 v., 0.5 amp. (112, 171).....	63.00
3.3 v., .06 amp. (199, 299).....	7.40
3.3 v., 0.12 amp. (120, 220).....	14.80
1.1 v., 0.25 amp. (WD 11, 12)	30.25
3.3 v., 0.132 amp. (222, 322)....	16.25

Note: When providing current for 3- or 1.1-volt tubes, be sure to turn R4 well in before turning on the current; then adjust to the voltage needed.

Sample application: Five tubes in receiver, three 201As, one 200-A, one 171. Total wattage required by the first four, 31.5x4=126; add 63 watts for the 171; total 189 watts. Obtain with two 75-watt lamps and one 40.

**List of Parts Used**

- Two Aerovox 2,000-mf. dry electrolytic "A" condensers, C1-C2;
- Two Todd type-C2 chokes, 2-amp., 1/4-henry, L1-L2;
- One 7-ohm Todd special heavy-duty resistor, R5;
- One Todd special relay, L5;
- One Flechtheim "B" condenser bank, 450-volt rating; 2-2-8-1-1-mf., C-3, 4, 5, 6, 7;

**Hotel Directory of the Radio Trade**

**HOTEL MARYLAND**  
CHICAGO ILLINOIS

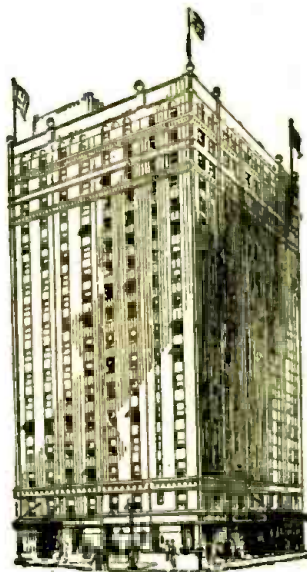

350 Rooms

All with Bath

RATES \$2.50 PER DAY AND UP

H. H. DECKER, Manager

900 Rush Street - - On the Edge of the Loop

In the heart of the "Gold Coast"

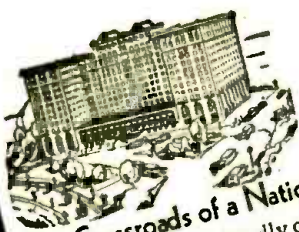

**The Crossroads of a Nation**

THE DRAKE is admittedly one of the great hotels of the world... the stopping place of seasoned travelers. Rooms are spacious and smartly elegant... continental atmosphere. Available, also, is an experienced Travel Bureau... to relieve you of every travel detail. Rates begin at \$5 per day. Permanent Suites at Special Discounts.

**THE DRAKE**  
HOTEL, CHICAGO  
Under Blackstone Management

"AN ADDRESS OF DISTINCTION"



**Famous**

For years as the hotel where courteous service, unexcelled food and comfortable rooms make a visit to Chicago a memorable event. The atmosphere prevailing is surprisingly homelike. Directly adjoining principal office buildings, shops and theatres.

Rooms, \$2.50 up—  
with bath \$3.50 up

**NEW BISMARCK**  
HOTEL CHICAGO

Write for Booklet with city map

**TURN TO PAGE 246**

and read of the interesting announcement regarding technical, mechanical and home workshop magazine which is now published.

# Over the Mountains from Los Angeles

## 559 Miles

### ON 11 Gallons of GAS



Think of it! FIVE HUNDRED FIFTY-NINE MILES over rough mountainous country burning only ELEVEN GALLONS OF GASOLINE. Imagine more than FIFTY MILES TO THE GALLON. That is what the WHIRLWIND CARBURETING DEVICE does for D. R. Gilbert, enough of a saving on just one trip to more than pay the cost of the Whirlwind.

## THE WHIRLWIND SAVES MOTORISTS MILLIONS OF DOLLARS YEARLY

Whirlwind users, reporting the results of their tests, are amazed at the results they are getting. Letters keep streaming into the office telling of mileages all the way from 22 to 59 miles on a gallon, resulting in a saving of from 25% to 50% in gas bills alone. Mark A. Estes writes: "I was making 17 miles to the gallon on my Pontiac Coupe. Today, with the Whirlwind, I am making 35.5-10 miles to the gallon." P. P. Goerzen writes: "34-6-10 miles with the Whirlwind, or a gain of 21 miles to the gallon."

R. J. Tulp: "The Whirlwind increased the mileage on our Ford truck from 12 to 26 miles to gallon and 25% in speed." Car owners all over the world are saving money every day with the Whirlwind, besides having better operating motors. Think what this means on your own car. Figure up your savings—enough for a radio—a bank account—added pleasures. Why let the Oil Companies profit by your waste? Find out about this amazing little device that will pay for itself every few weeks.

### FITS ALL CARS

In just a few minutes the Whirlwind can be installed on any make of car, truck or tractor. It's actually less work than changing your oil, or putting water in your battery. No drilling, tapping or changes of any kind necessary. It is guaranteed to work perfectly on any make of car, truck or tractor, large or small, new model or old model. The more you drive the more you will save.

### SALESMEN AND DISTRIBUTORS WANTED FREE SAMPLE AND \$100.00 A WEEK OFFER

Whirlwind men are making big profits supplying this fast selling device that car owners cannot afford to be without. Good territory is still open. Free sample offer and full particulars sent on request. Just check the coupon.

### GUARANTEE

No matter what kind of a car you have—no matter how big a gas eater it is—The Whirlwind will save you money. We absolutely guarantee that the Whirlwind will more than save its cost in gasoline alone within thirty days, or the trial will cost you nothing. We invite you to test it at our risk and expense. You are to be the sole judge.

### FREE TRIAL COUPON

Whirlwind Mfg. Co., 999-112-A Third St., Milwaukee, Wis. Gentlemen: You may send me full particulars of your Whirlwind Carbureting device and free trial offer. This does not obligate me in any way whatever.

NAME .....  
ADDRESS .....  
CITY .....  
COUNTY ..... STATE.....  
 Check here if you are interested in full or part time salesman position.

## AGENTS Your chance to earn \$10 a Day and get Hose without extra cost

Just demonstrate and take orders for this fine quality warrantee Hosiery for men, women and children. Over 100 styles and shades. Pure thread silk, silk and lisle, chiffon, wool mixtures and other fabrics, both regular and full-fashioned. Hose for personal use furnished without extra cost.



**Wear Warrantee Furnished**

Mills of Minn. made \$120 in one week. Mrs. Gleason of Ga. made \$23 in one day. These records can be equaled by pleasant work and following my simple, easy instructions. Build a permanent business with a steady daily income. Get extra bonuses. No experience necessary. Mail coupon today. L. E. WILKIN, General Manager.

**MAIL COUPON! Send No Money**

**Auto GIVEN**  
Every producer offered new Ford Car and hose for personal use as extra bonus.  
No contest.

**WILKIN HOSIERY CO., Dept. 2310, Greenfield, Ohio**

**Mail This Coupon Quick!**

L. E. WILKIN, General Manager  
Wilkin Hosiery Co., Dept. 2310, Greenfield, Ohio  
Rush full particulars. I am sending hose size.

Name ..... Size .....

Street or R. F. D. ....

Post Office ..... State .....

- One Flechtheim 4-mf. fixed condenser, 450-volt, C8;
- Two Todd type-C30 chokes, 30-henry, 85-millamp., L3-14;
- One Electrad "Truvolt" 5,000-ohm variable resistor, R1;
- One Electrad "Truvolt" 8,000-ohm adjustable resistor, R2;
- One Carter "Midget" type-MW heavy-duty (2-amp.) 6-ohm rheostat, R3;
- One Frost 30-ohm rheostat, R4;
- One Readrite 0-8-scale voltmeter, V;
- Two Cutler-Hammer power toggle switches, S1-S2;
- Two 3-amp. fuses, F, with porcelain sockets;
- One panel, about 7x7; baseboard 9x14, binding posts, screws, wire, etc.

### RADIO TAX LAW TESTED

IN pursuance of its search for new methods of taxation, the legislature of South Carolina recently imposed a specific tax upon radio equipment. The Radio Manufacturers Association is supporting a legal test of the constitutionality of this legislation; and three separate bills for injunction against the state officials have been filed at Charleston, S. C., by a broadcast station (WBT, of Charlotte, N. C.), a radio distributor and an individual set owner. The cases will be heard in the federal district court, where a preliminary injunction was granted by Judge Ernest F. Cochran.

The tax on sets was graduated, from fifty cents each on those worth less than \$50, up to \$2.50 each on those worth above \$500.

### THE VOICE OF THE WEST

CHINA, which has for two thousand-odd years been considered "Far East," may soon be ranked as Far West by radio fans, especially on the Pacific coast. A sixty-kilowatt broadcast station has been ordered for Nanking. Nevertheless, while time difference makes it much easier to hear America in Europe than vice versa, the eight hours' difference in time across the Pacific may prevent program reception, except in winter; though some favored listeners have already heard the five-kilowatt stations of Japan and Australia.

### CALLING THE MARINES

AUTOMATIC radio equipment, which sends out an "SOS" in a manner not unlike that in which a fire alarm box operates, is now available for ships and airplanes. On the Chinese rivers, it is now said, automatic radio alarms are carried by shipping, for use in case of attacks by pirates. The transmitter is fitted into a fireproof safe; if this is turned on and locked, it will continue to send out a message of distress, while the operator is busy fighting off the enemy.

### RADIO MORE NEEDED THAN WATER

"If you don't like the location, move." A California ranchman, says the *Christian Science Monitor*, finally took this advice to better his radio reception. His home was too near high-power lines, and too far from a good moist ground: and, on the advice of engineers that he could not get good reception where he was, he moved his ranchhouse down to the well—from which he had been toting water for twenty years.

# EVERYDAY MECHANICS

## Will Increase Your Earning Power

Whatever your job, you will find in EVERYDAY MECHANICS labor-saving kinks which will help you to get more work done in less time and will bring you recognition from your employers. If you do machine shop work of any kind, auto repairing, sheet metal work, electrical work, farming, concrete work, carpentering, tool making, poultry raising, painting, plumbing, masonry, building, glass work, welding or general repairing, a yearly subscription to EVERYDAY MECHANICS will pay for itself a thousand times over.

## Make Money in Your Spare Time

Hundreds and thousands of amateur mechanics and spare-time workers are making \$10 to \$100 a week EXTRA MONEY by servicing vacuum cleaners and washing machines, repairing automobiles, manufacturing book-ends, lamp-shades, tool chests, chairs, tables, unique ornaments, concrete articles, photo frames, flower boxes, ladders, tanks, garages, gliders and innumerable products in everyday use. EVERYDAY MECHANICS teaches you HOW to turn your spare time into MONEY. EVERYDAY MECHANICS is staffed by real engineers and practical mechanics who tell you about the latest ideas and inventions which you can CAPITALIZE to your OWN PROFIT.

## Contents

SPACE DOES NOT PERMIT US TO PRINT THE 60 FEATURES IN THE CURRENT ISSUE OF EVERYDAY MECHANICS. But the following titles will give you some indication of the interesting and valuable contents:

- HOW TO BUILD A SECONDARY AMPHIBIAN GLIDER
- A VENETIAN IRON GRILL FOR YOUR FRONT DOOR
- EASILY MADE PORTABLE SEE-SAW FOR CHILDREN
- A CHAMPION TWIN STICK PUSHER MODEL AIRPLANE
- HOW TO BUILD A PERPETUAL MOTION MACHINE
- HOW TO MAKE AN EFFICIENT WAVE TRAP
- THE MECHANICS OF SUGGESTION
- AN OCEAN LINER WITH WATER WINGS and fifty-two other helps and fascinating features about Automobiles, Aviation, Chemistry, Construction Work, Electricity, Magic, Metal Work, Radio, Photography, Shop Work, Woodworking and new devices.

## A Special Offer

In order that you may not miss any of the splendid features now appearing in EVERYDAY MECHANICS and opportunities for making money from the unique 'tips' that are published in every issue, the publishers will send this valuable magazine DIRECTLY TO YOUR HOME every month at a reduction of ONE-THIRD off the usual subscription price. But to take advantage of this offer you must act quickly. Tear off the coupon below and mail it today. YOUR FIRST COPY OF EVERYDAY MECHANICS WILL BE SENT YOU BY RETURN MAIL.

### Mail Coupon Today

EVERYDAY MECHANICS PUB., Inc. 96-98 Park Place, New York, N. Y. RC-10  
Please rush my first copy of EVERYDAY MECHANICS. I enclose

- \$1.00 for one year's subscription
  - 1.90 for two years' subscription
  - 2.70 for three years' subscription
- (Check one of the above)

NAME .....

ADDRESS .....

CITY ..... STATE.....

NOTE: This special subscription offer may be withdrawn at any time.



# New Radio Devices for Shop and Home

(Continued from page 223)

set, is capitalized by the Alden Products Co., Brockton, Mass., who have just developed a cable plug in four- and five-prong types, illustrated in Fig. C.

The cable leads from the dynamic reproducer are led through a cap and are then soldered into the prongs of the plug. When the cap is threaded into position it tightly clamps the reproducer cable.

This device should find application, wherever it is desired to connect four or five leads into a tube socket.

## PHONOGRAPH TURNTABLE

TO the line of the Bodine Electric Co., Chicago, Ill., has been added an improved "Model RC-12," illustrated in Fig. D.

Included in the motor is an oversize fan which ventilates the stator and keeps the motor cool. The totally-enclosed reduction gear has fewer parts; and their design is more efficient. The governor includes a steel

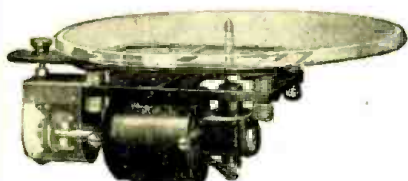

Fig. D

A new motor-driven turntable for phonograph disc operation, which is quiet, cool, and acoustically insulated from the cabinet to which it is mounted.

double brake that is noiseless. Cabinet resonance does not enter into the reproduction by causing low-note distortion; since motor and governor are supported by four double springs, provided with dampers, that entirely isolate the motor mechanism from the cabinet.

## MIDGET FILTER CONDENSERS

WHERE space is at a premium, the type of fixed condenser shown in Fig. E, manufactured by A. M. Flechtheim & Co., New York City, is specially useful.

The size shown is the 1-mf. type "HS," which is rated at 660 volts, R.M.S., or 1,000 volts, D.C.; although its dimensions are only 2 x 1 1/8 x 1 1/8 inches. The capacity value is accurate within 5 per cent.



Fig. E

Special dielectric material of high insulating value, though thin, makes these high-voltage by-pass condensers very small.

The use of a special impregnated dielectric tissue, having an insulation resistance of 1,000 ohms per microfarad makes the small dimensions a possibility. The power factor is less than 1 per cent. A non-inductive type of winding is used.

Where type '50 tubes are used the type "HS" condenser is recommended, in capacities of 1, 2, or 4 mf. The type "HV" unit is designed for amplifiers using type '45 tubes, and operation on 800 volts, D.C., or 440 volts, R.M.S. Capacities available in this model are: .05, 0.1, 0.25, 0.5, 1, 2, and 4 mf.; and a bank, containing capacities of 0.2-4-4 mf.

Although of particular value as a small-space condenser, this component may be used wherever a condenser is needed in these values.

## AN IGNITION FILTER KIT

CONNECTING 25,000-ohm resistors in the high-voltage leads of an automotive ignition system, and by-passing generator contacts with a fixed condenser of 0.1-mf. capacity, is not a new idea for purposes of eliminating spark interference with broadcast reception; but developing a convenient kit of special units for this purpose is probably original with the Filton Mfg. Co., New York City.

In Fig. F is illustrated the kit of parts that compose the "Ex-Stat Ignition Filter System." These kits come in three sizes and include resistors and capacities for 4-, 6-, or 8-cylinder cars.

The main feature, of this combination of four resistors and two by-pass condensers, is that they are designed specifically for use in automotive installations, ashore and afloat, and are not just a collection of ordinary units having the same electrical values. In the first place, regular fixed condensers do not stand the heat that exists inside the hood of the automobile, according to the engineering department of this company. In the second, an ordinary resistor mounting will not stand the flexing and vibration found in practice; special construction is necessary to prevent this. The features embodied in this kit are to be recommended to the man who wants to be certain that there will be no failures in the ignition system at inopportune moments.

(Continued on page 248)

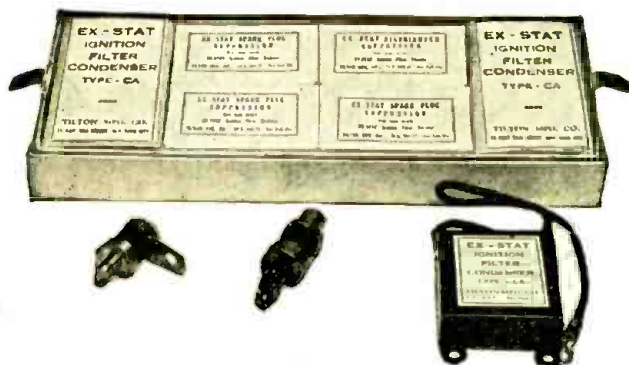

Fig. F

The kit of resistors and condensers illustrated was designed primarily for use in automotive radio installation to suppress ignition interference. There are several assortments, each for a specific type of car, available in this form.

**1931**

**LOWEST WHOLESALE PRICES!**

**FREE**

**RADIO CATALOG**

Everyone interested in RADIO should have this Catalog. Solid with "Specials" from cover to cover. Teeming with values... every item a feature. All latest sets and equipment. Screen Grid, A. C., Humless, all electric sets... also battery operated sets and direct current sets. Dynamic speakers, beautiful consoles, kits and parts. Wholesale prices. Astounding savings. Get this FREE bargain book today

**Chicago Salvage Stock Store**  
509 S. State St. Dept. 540, Chicago

## TRUSS USERS

STUART'S ADHESIVE PLAPAO-PADS are patentably different—being mechanico-chemical applicators—made self-adhesive purposely to keep the musculo-tonic called "PLAPAO" continuously applied to the affected parts, and to minimize danger of slipping and painful friction. The fabric is soft as velvet, and being adhesive—

—clings closely to the body—



—without straps, buckles or springs.

Easy to apply, comparatively inexpensive and comfortable.

For almost a quarter century stacks of sworn testimonials from many different countries report success, without delay from work. Process of recovery natural, after which no further use for a mechanical support. Test of the remedial herbal factor "PLAPAO" sent you absolutely FREE. No charge for it is now or ever. Write name on coupon NOW and mail TODAY.

Plapao Co., 10 Stuart Bldg., St. Louis, Mo.

Name .....  
Address .....

Free — Trial Plapao — Free

## QUIT TOBACCO

No man or woman can escape the harmful effects of tobacco. Don't try to banish unaided the hold tobacco has upon you. Join the thousands of inveterate tobacco users that have found it easy to quit with the aid of the Keeley Treatment.

### KEELEY Treatment For Tobacco Habit

Successful For Over 50 Years

Quickly banishes all craving for tobacco. Write today for Free Book telling how to quickly Free yourself from the tobacco habit and our Money Back Guarantee.

**THE KEELEY INSTITUTE**  
Dept. L-706 Dwight, Illinois

## RADIO BARGAINS

Low Power Transmitter adaptable for phone or code. With plug-in rolls ..... \$14.75  
 Auto Radio—Uses 3 334 and 2 227 tubes, single dial, tremendous volume. Compact. Fits any car. 20.00  
 B Eliminator, Bone Dry with 280 tube, 180 volts, will operate up to ten tube set, fully guaranteed.. 6.75  
 AC—A B C Power Packs. 8.75  
 Power and Filament Transformers for 226, 227 and 171 tubes, with double choke. 4.00  
 Tubes: 171 type, 30-day replacement guarantee. No. 210, \$2.25; No. 250, \$2.35; No. 281, \$1.85; No. 245, \$1.25; No. 224, \$1.25; No. 227, 75c; No. 226, 65c; No. 171, 75c.  
**CHAS. HOODWIN CO.**  
 4240 Lincoln Ave. Dept. K-15 Chicago

# Prices SLASHED on Screen Grid Tube 224!

## EVERY TUBE IS PERFECT

By concentrating our production on ONE type of tube, we have been able to produce one that is PERFECT — one that is sure to give more than satisfying results—in tone quality and long life.

We manufacture 224 Type Tube EXCLUSIVELY, and will back unconditionally any statement we make about it.



OUR PRICE  
**75c**

**ORDER TODAY! ORDERS LESS THAN \$5.00 NOT ACCEPTED. NO REPLACEMENTS MADE AFTER FIVE DAYS. 20% REMITTANCE OF FULL AMOUNT MAY BE SENT WITH ORDER — BALANCE ON RECEIPT OF GOODS. F.O.B. NEWARK ONLY.**

### DISCOUNTS

Reg. List \$3.30    50 Tubes or over 10%. 500 tubes or over 10% and 10%.

### FEDERAL DISTRIBUTING COMPANY

Specialists in the Manufacture of 224 Tubes

222-26 Halsey Street

Market 2-2580

Newark, N. J.

## CLASSIFIED ADVERTISEMENTS

### ANALYZERS — TESTERS

WE ARE DISTRIBUTORS for Weston, Jewell and Dayrad set testers, analyzers and meters. Orders given prompt attention at dealers discounts. Sun Radio Co., 64 Vesey Street, New York City.

### CHEMICALS

BOOKLET OF EXPERIMENTS and chemical catalog, 15c. General Chemical Company, Box 397, Reading, Penna.

### DETECTIVES

DETECTIVES Earn Big Money. Excellent opportunity. Experience unnecessary. Particulars Free. Write, George Wagner, 2190B Broadway, N. Y.

### INSTRUCTION

BE THE LICENSED RADIO DOCTOR of your community. Earn \$7.00-\$10.00 spare time evenings. Write now for free booklet, "Why the Radio Doctor?" Radio Doctors, Inc., Dept I, 131 Essex Street, Salem, Massachusetts.

GET OUTDOOR GOVERNMENT JOBS; \$135-\$200 month; vacation. Patrol forests and parks; protect game. Details free. Write, Delmar Institute, B39, Denver, Colo.

### INVENTIONS

INVENTIONS COMMERCIALIZED. Patented or unpatented. Write Adam Fisher Mfg. Co., 594 Enright, St. Louis, Missouri.

### MISCELLANEOUS

BURIED METAL LOCATING By Radio. Something absolutely new. Profitable, fascinating, respectable business. Details for Red Stamp. Exchange, Box 607, El Monte, California.

TO THE MAN OR WOMAN seeking friendship or matrimony, we offer exclusive service. Box 1540-W, Sta. C, Los Angeles, Calif.

### PRINTING

100 OF EACH, Business letterheads and Envelopes, printed, your copy \$1.50. CRANE, Box 7622 Kansas City, Missouri.

### RADIO

SERVICE MEN, ATTENTION — Speakers re-wound, magnetized, repaired, \$2.00 to \$2.75. Complete Power Pack Service—Transformers rewound, condenser blocks repaired, resistors duplicated. Guaranteed. Clark Brothers Radio Co., Albia, Iowa.

RECEIVE MORE DISTANT STATIONS. New frequency selector. Guaranteed. \$1.00 Postpaid. NOEL, 1502. Pittston, Scranton, Pa.

### SONG POEM WRITERS

LYRIC WRITERS: I compose better music cheaper. Ernest Deininger, 2827 Papin Street, St. Louis, Mo.

### COMPACT LINE-VOLTAGE REGULATOR

THOUGH the radio unit pictured in Fig. 1 G is called by its makers, the Protecto Mfg. Co., of New York City, the "Automatic Voltage Regulator," the instrument does not exercise control of the line supply to maintain constant voltage with varying load. What it does do, however, is to drop the line potential about ten volts. In other words, if the line voltage is 110 volts, the resistor probably will not be needed; if it is 120 volts, or 130 volts, the line voltage will be reduced, respectively, to either 110 volts or 120 volts when this unit is plugged into the line outlet receptacle and the radio set is plugged into the other end of the unit.

"Models A," "B" and "C" are for sets drawing up to 150 watts, up to 300 watts, and over 300 watts, respectively. The case is made of a special green-tinted composition which successfully resists the effect of the heat developed when the unit is in use. It contains, of course, a resistor in one side of the line.

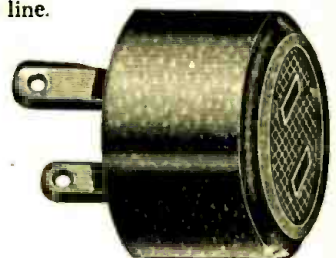

Fig. G

A simple device which overcomes excess line-voltage and thereby adds to the life of radio tubes. It is inserted into the house receptacle, and takes the plug from an electric receiver or power unit.

### TWENTY-FIVE-MILE LOUD SPEAKER

IN Berlin, Germany, a recent surprise was given to the citizens by a concert, delivered from a loud speaker on the roof of a large technical laboratory, which was audible over an area of several hundred square miles. This giant instrument, the unit of which takes a current of 120 amperes and weighs over a hundred pounds, has a diaphragm a sixteenth of an inch thick; and the air waves, it is said, could be felt fifty yards away.

### NEW SHORT-WAVE STATIONS

In addition to the present short-wave station at Cecchignola, near Rome, Italy, is to have another high-power station near Turin, which will also operate on 80 meters. It is said that picture transmission is the ultimate aim.

Bohemia (Czechoslovakia) also is said to be acquiring two new short-wave stations, principally for communication with the United States on between 10 and 20 meters, with a power of 20 kilowatts each.

Sardinia has been linked with the mainland and telephone system of Italy by a 10-meter transmitter which spans the Tyrrhenian Sea, over a hundred miles. This ultra-short wave, it is thought, will not be receivable except in the vicinity of the two operating stations, however.

The new Vatican City transmitter, it is announced, works on 50.26 and 19.84 meters. As yet it has not been formally opened.

Belgrade, Yugoslavia, is reported testing on 30 meters between 4 and 5 p. m. E.S.T., on Mondays.

Toulouse, France, has amateur broadcasts on 49 meters Sunday afternoons from 2:30 to 4:00, E.S.T.

The short-wave transmitter MTH, Rio de Janeiro, Brazil, has gone up from 31.75 to 49 meters, according to advices sent to the International S. W. Club. They were heard from 5 to 7 p. m.

HRB, Tegucigalpa, Honduras, is now on 48.62 meters.

**WE MATCH PANTS**  
To Any Suit!  
Double the life of your coat and vest with correctly matched pants, 100,000 patterns. Every pair hand tailored to your measure; no "readymades." Our match sent FREE for your O. K. before pants are made. Fit guaranteed. Send piece of cloth or vest today. SUPERIOR MATCH PANTS COMPANY 115 So. Dearborn Street, Dept 379, Chicago



SOMETHING DIFFERENT  
No Flint. No Friction.  
MAKE UP TO

**\$40 A DAY**

Showing My Mystery Lighter to Men. What Makes It Light? All Guaranteed. No Flint or Friction. New Principle of Ignition. Sample with Sales Plan, 25c. Sample Gold or Silver Plated, \$1.00. Agents write for proposition. NEW METHOD MFG. CO., Desk SF-10, New Method Bldg., Bradford, Pa.

**The TRANSMITTER UNIT**  
with 100 Uses  
**95¢**  
SKINDERVIKEN MICROPHONE BUT-TON—Powerful Speech and Phonograph Amplifier—Detentophone, etc., etc. One unit 95c.—two \$1.75, with 12-page booklet of experiments. Sent C.O.D. in U. S. only. PRESS GUILD, INC., 16 Murray St., Dept. D-1030, New York, N. Y.

**PATENTS** Write for Free Guide Book, "HOW TO OBTAIN A PATENT" and Record of Invention Blank. Send model or sketch and description of your invention for our Free Opinion whether it comes within Patent Office Rules. RADIO and ELECTRICAL Cases a Specialty. Prompt, Efficient Service. PAYMENT OF FEES IN INSTALLMENTS VICTOR J. EVANS & CO., 923 - 9th, Washington, D. C.

# Reviews of Radio Literature

(Continued from page 223)

There is nothing fantastic, nothing impossible nor improbable, nothing to insult the intelligence of the reader, in the conservative opinions expressed in this book.

In a word, *Radio and Its Future* is a compilation of the concisely-expressed views of authorities in radio.

The chapter, "American Beginnings," opening the book in Part I, "Broadcasting," is written by H. P. Davis, Vice-President of Westinghouse Electric and Mfg. Co. The chapter, "The Radio Structure" is written by the editor of the book, Martin Codel, of the North American Newspaper Alliance. The self-explanatory titles of the remaining chapters and their authors are listed thus: "National Broadcasting," Merlin Hall Aylesworth (President, National Broadcasting Co.); "The Business of Broadcasting," William S. Hedges (President, National Association of Broadcasters); "Audible Advertising," Roy S. Durstine (Vice-President and General Manager, Batten, Barton, Durstine & Osborn, Inc.); "Radio Entertainment," William S. Paley (President, Columbia Broadcasting System); "Radio and Education," Joy Elmer Morgan (Editor, The Journal of the National Education Association); "International Broadcasting," C. W. Horn (General Engineer, National Broadcasting Co.). Part II, "Communications": "Radio in World Communications," Maj.-Gen. James G. Harbord (Chairman of the Board of Directors, Radio Corp. of America); "Maritime Radio," A. Y. Tuel (Vice-President and General Manager, Mackay Radio and Telegraph Co.); "Radiotelephony," E. H. Colpitts (Asst. Vice-President in charge of research and development, American Telephone and Telegraph Co.); "Radio for Safe Flying," Fred C. Hingsburg

(Chief Engineer, Airways Division, U. S. Dept. of Commerce); "The Radio Amateur," Hiram Percy Maxim (President, The American Radio Relay League; President, The International Amateur Radio Union); "Radio in Military Communications," Maj.-Gen. George S. Gibbs (Chief Signal Officer, U. S. Army); "Radio in U. S. Naval Communications," Capt. Stanford C. Hooper, U. S. Navy (Director of Naval Communications). Part III, "Industry": "Art and Industry," David Sarnoff (President, Radio Corp. of America); "Laboratory and Factory," Frederick A. Kolster (Chief Research Engineer, Kolster Radio Corp.); "The Radio Market," O. H. Caldwell (Editor, "Radio Retailing," and "Electronics"; Former Member of the Federal Radio Commission); "Radio Production," William C. Grunow (Vice-President, The Grigsby-Grunow Co.). Part IV, "Regulation": "Radio and the Law," Louis G. Caldwell (Former General Counsel, Federal Radio Commission; Chairman, Standing Committee on Communications, American Bar Association); "International Aspects," Lieut.-Comdr. T. A. M. Craven, U. S. Navy (Technical Advisor, electrical communications conference at Washington, 1920; international conference at Washington, 1927; international conference at The Hague, 1929); "Radio by the American Plan," Clarence C. Dill (U. S. Senator; co-author, Radio Act of 1927); "A Commission on Communications," James Couzens (U. S. Senator; Chairman, Senate Committee on Interstate Commerce). Part V, "Some Scientific and Other Consideration": "How Radio Works," John V. L. Logan (Past-President, Institute of Radio Engineers; Author, "The Outline of Radio"); "Short Waves," A. Hoyt Taylor (Supt., Radio Division, Naval Research Laboratory; Past-President, Institute of Radio Engineers); "The Broadcasting Band," J. H. Dellinger (Chief, Radio Section, U. S. Bureau of Standards; Past-President, Institute of Radio Engineers); "Long Waves," L. W. Austin (Chief of Laboratory for Special Transmission Research, U. S. Bureau of Standards; Past-President, Institute of Radio Engineers); "Television," Herbert E. Ives (Electro-Optical Research Director, Bell Telephone Laboratories); "The Future of Radio," Lee DeForest (Vice-President, DeForest Radio Co.; President, Institute of Radio Engineers, 1930).

A valuable cross-index concludes the index. It is to be regretted that the book includes such a small amount of illustration; this would reduce the impression of monotony.

*Radio and Its Future* contains a vast amount of valuable reference material for the technician; and the manner of presentation makes this information readily digestible by those to whom the term "radio" means a dial or two on a panel in a fancy cabinet.

(R. D. W.)

## With BYRD at the SOUTH POLE

AN album containing authentic views of the BYRD ANTARCTIC EXPEDITION. Each of the seventeen actual photographs presents a thrilling story of the hazardous life at the far end of the world. Send twenty cents, stamps accepted, for your copy of this interesting album of the greatest expedition of all times.

### GRENPAK COMPANY

245-R Greenwich St. New York, N. Y.

## SONG WRITERS!



Substantial Advance Royalties are paid on work found acceptable for publication. Anyone wishing to write either the words or music for songs may submit work for free examination and advice. Past experience unnecessary. New demand created by "Talking Pictures" fully described in our free book. Write for it Today—Newcomer Associates 751 Erie Building, New York, N. Y.

## Book Lovers Ex-Libris-Book Plates

LATEST series of OLD MASTERS book-plates, reproducing antique woodcuts and engravings. Unique creations for book-lovers who appreciate the unusual. Write for illustrated catalogue and specimen, enclose 10 cents for mailing charge. ISKOR PRESS, INC., 19 Park Place, Dept. D-1030, New York, N. Y.

## DO YOU WANT TO STOP TOBACCO?



Banish the craving for tobacco as thousands have. Make yourself free and happy with Tobacco Redeemer. Not a substitute, not habit forming. Write for free booklet telling of injurious effect of tobacco and dependable, easy way to relieve the craving many men have. **FREE BOOK** Newell Pharmacal Co. Dept. 528 Clayton, Mo.

## PROCEEDINGS OF THE RADIO CLUB OF AMERICA, June, 1930. (Vol. 7, No. 6.) 8 pages and self-cover, 9 by 12 in. Single copy price, 50 cents.

This issue of the well-known *Proceedings* is devoted to an address before the Club by Arthur V. Nichol, assistant chief engineer of the Automobile Radio Corp., reviewing the problems of automotive radio design and installation from an engineering standpoint. Many interesting details are contained in this talk. Among them is to be noted that interference suppression presents a difficulty in high-speed and 8-cylinder engines; because a resonant condition may be set up in the filter circuit and cause harm to the system. Methods of testing the efficiency of oscillation suppressors, by neon lamps or vacuum-tube voltmeters, are outlined.

## SUMMARY OF PROGRESS IN THE STUDY OF RADIO WAVE PROPAGATION PHENOMENA, by G. W. Kenrick and G. W. Pickard. Reprint from the *Proceedings of the I. R. E.* 20 page, 6 by 9 in.

This pamphlet affords a concise review of the theoretical and practical work which has been done, in the endeavor to explain by definite laws the mysterious actions of radio waves after they have left the transmitter. In this field of research, the paper's co-author, Greenleaf W. Pickard, has been one of the most distinguished investigators. For over twenty-five years incessant and laborious observa-

# SET BUILDERS

and

# EXPERIMENTERS

## Bargain List

### All Parts New and Fully Guaranteed

**RADIOLA No. 44 SCREEN GRID RECEIVER.** Complete with tubes and Antenna kit but less speaker, \$38.50 (Listed at \$110.00 less tubes).

**R.C.A. 103 SPEAKER** for this receiver or any other, only \$5.75.

**SONORA FOUR-TUBE TUNERS** for three 224 and one 227 tubes, only \$27.75.

Same tuner for four 227 tubes, \$20.00. For three 228's and one 227, \$16.00.

For four Arcuturns 15-volt A.C. tubes, \$16.00. Sizes 13 x 6 1/4 x 5 3/4 inches, an excellent tuner for that Loftin-White amplifier or our R-245 Power Amplifier and Power Pack listed below, will make a great receiver.

**R-245 POWER AMPLIFIER** furnishes all voltages for a stage of 227 transformer coupled audio feeding two 245 tubes in parallel and in addition will furnish all voltages for a receiver using either 226 or 227 tubes (also 224 type) the arrangement of parts is very neat, a Victor power transformer is used with an additional transformer to furnish 2.5 volts at 12 amperes, uses 1-280, 1-227 and 2-245 type tubes, the voltage divider taps are variable and when set may be tightened and left. Mounted and wired, \$20.00.

**WIRE WOUND RESISTORS** for use as voltage dividers, transmitter grid leaks or any other electrical work where rating is not exceeded. 250-watt size variable taps. Following sizes—200, 750, 900, 1,400, 1,650, 11,000, 13,600, 13,650, 15,000, 16,000, 17,000 and 75,000 ohms. Each, 75c.

**750-OHM WIRE WOUND GRID SUPPRESSORS**, each, 25c.

**HI-WATT RESISTORS, 5 AND 10-WATT**, grid leak type with pig-tail connectors in 500, 2,000, 4,700, 10,000, 15,000, 20,000, 25,000, 250,000 and 500,000-ohm sizes, each 25c.

**50,000-OHM WARD LEONARD** 20-watt resistor, tapped at 20 and 30 thousand, size 4 x 1/2 inch, each 75c. 6,140-ohm, tapped at 5,000, 940 and 500 ohms, same size, each 75c. 200-ohm 60-watt, size 3 1/2 x 1/2 inch, each 75c. These W.L. wire wound resistors are replacements for Columbia and Kolster receivers.

**POWER TRANSFORMER No. A-8410** for Columbia Receiver No. 300 Primary, 110-v., 60-cycles; secondary, 1080 center-tapped (125 mills) 1.5 volts for 228's, one 7.5 volt C.T. winding for one or two 210's or 250's and 15 volts for two 281's in series. List price \$25.00. Our price \$4.75 each.

**KOLSTER TYPE "M" POWER PACK**, part No. A-6410 for Kolster 6-J, J-M, 6-R, 6-K and 6-F sets. Furnishes A, B and C current to a receiver using four 226, one 227 and one 171A tubes. Employs a 280 rectifying tube. Listed at \$70 each without tube. Our price including 1-UX280 tube, \$11.75.

**FILTER AND BY-PASS CONDENSERS, 16.5-mfd.**, 1,000-volt filter condenser block at only \$7.00.

**600-VOLT FILTER CONDENSERS, 4 mfd., \$1.75;** 2 mfd., \$1.00; 1 mfd., 60c.

**400-VOLT CONDENSERS, 2 mfd., 60c.; 1 mfd., 50c.;** 1 mfd., 25c.; 200-volt by-pass condensers, 2 mfd., 50c.; 1 mfd., 35c.; .5 mfd., 25c.; Dubilier .5 mfd., 200-volt condensers 35c.; all voltages are D.C. working voltages and not the A.C. voltage. By-Pass condenser block containing 1-.5 mfd. and 3-.1 mfd. condensers, each 90c.

**60 M.H. RADIO FREQUENCY CHOKES, 75c.;** R.C.A. 30-henry 80-mill double filter chokes, each \$3.20.

**AUDIO TRANSFORMERS, 1 1/2 to 1, 3 to 1, 5 to 1** and 10 to 1, each \$1.00.

**POWER TRANSFORMER, 375-375 3, 5, 2.5 1.5 and 1.5 volts and 2 filter chokes suitable for 10-tube set,** each \$5.50.

**MISCELLANEOUS JACKS**, all types, each 15c.

**VARIABLE CONDENSERS**, any size, 75c.

**SAMSON CONDENSERS**, any size, \$1.50.

**UX SOCKETS**, each 35c.; UY type, 40c.

**4-IN. DIALS, 18c.;** 1 1/2-inch knobs, 12c.; Carter wire wound resistors, all sizes, each 20c.; Plain Binding Post, 5 for 15c.

**TUBES, guaranteed 60 days—224—\$2.00, 227—\$1.25,** 245—\$1.75, 280—\$1.50, 228—87c., 171A—\$1.12, 112A—\$1.02, 201A—60c.

## CARTER RADIO and ELECTRIC CO.

1073 W. 48th St. • • Norfolk, Va.

# RADIO Service Men!

Products listed below are made by leading radio manufacturers and offered at prices far below the manufacturing cost. Stocking them for future use will save you money.

## VICTOR "ABC" POWER TRANSFORMER

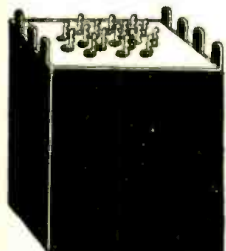

105-115 VOLT  
60 CYCLE

Supplies voltages for  
6-226 tubes  
1-227 tube  
1-280 tube  
2-245 tubes

350 Volts "B, C"

Our Price  
**\$2.75**

## PUSH-PULL AUDIO TRANSFORMERS

FOR 245-171 TUBES

Flat characteristic curve obtained by using these transformers in a push-pull stage.

Finished in Bronze

**\$3.00**

Pair



## COMBINATION "A B C" AIREX POWER PACK



Dealers Price  
Now  
**\$5.45**

WIRED READY FOR USE

Built with high-grade parts. Supplies "A, B, C" Voltages for

5-226's 2-227's 2-171-A's 1-280  
105-120 Volts — 50-60 Cycle

Delivers over 125 Mils and up to 300 volts "B" power. The Power Transformer is designed to take care of a D.C. DYNAMIC SPEAKER, two connections being provided on the pack for same. It need not be used if not wanted, but may come in handy at some future date.

280 Rectifier Tube **95c.**

All products shipped C.O.D. immediately upon receipt of order

Grenpark Tool Company  
245 Greenwich St. - New York City

# WORLD-WIDE SHORT WAVE RECEIVER

ONLY **\$6.45** Span the World with this Set!

A new radio thrill for you! Listen in DIRECT to London, Paris, Berlin, Buenos Aires and other broadcasting stations throughout the world via short waves. Enjoy unique foreign programs from strange lands. Your ordinary receiver cannot tune in these long wave stations. WORLD-WIDE RECEIVER gets 14 to 550 meter stations with surprising clarity. **SEND NO MONEY!** Just write your name and address on a postcard and ask us to send you this wonderful guaranteed short wave set. Pay postman \$6.45 plus a small delivery charge. All orders West of the Rockies must be accompanied by \$1.00 deposit. Foreign countries must remit in full. Write today!

CHAS. HOODWIN CO.  
4240 Lincoln Ave., Dept. K-150, CHICAGO

tions have been made, in the endeavor to learn what is going on in the conducting regions of the upper atmosphere, where most long-distance transmission is taking place. Since 1928, it is here affirmed, rapid progress has been made in this study; yet there are mysteries which are still baffling—such as the mysterious "echoes" reported by Ilals, Störmer and van del Pol, whereby signals are heard many seconds after their transmission. Many theoretical measurements have been made of the presumed Kennelly-Heaviside layer; and more reception data have been published during the past year than in any other similar period. The authors look hopefully to the forthcoming Goddard rocket experiments to answer more definitely many questions regarding the constitution and state of the gases in the upper air, which is at present above the reach of "sounding" devices.

The pamphlet covers briefly an enormous amount of scientific work, and is accompanied by a valuable bibliography of the information available for the serious student of this extremely technical subject.

**THE GENERAL RADIO EXPERIMENTER**, April, 1930. (Vol. 4, No. 11.) Eight pages, 6 by 9 in. Issued to a mailing list by General Radio Co., Cambridge, Mass.

This issue of a well-known house organ contains two articles: the first a description by Charles E. Worthen of an audio oscillator, which is held to a fixed tone by a tuning fork, for laboratory use. The second, by Arthur E. Thiessen, covers a laboratory-type audio amplifier, designed with removable transformers for experimental and comparative purposes. With a '45 output tube, an amplification gain of 40 decibels is shown to be flat over the range from 90 to 6,000 cycles, with a drop of two decibels at 40 and 8,000 cycles.

**MODERN SHORT-WAVE APPARATUS FOR EXCLUSIVE AMATEUR PURPOSES.** (Booklet No. 50.) Paper cover, 16 pages, 8½ by 11 in., illustrated. Published by Radio Engineering Laboratories, Long Island City, N. Y.

This catalog is one of the kind which will at once command the attention of the transmitting amateur; while the short-wave fan might find interest in the description of an amateur band receiver kit, in which suitable spreading of the short-wave channels on the selected bands is obtained by the use of a "tank" condenser. When the coil suited to one of the three bands (20, 40 and 80 meters) is put in place, the "tank" is adjusted to a calibration at which it tunes the coil to the bottom of the band. Tuning is then effected by means of a single-

plate vernier condenser. The convenience of the arrangement may be imagined, when it is considered how small a portion of the whole short-wave range these bands cover.

In addition, the design and data of a 10-watt transmitter, furnished in kit form, a linear amplifier, and a modulator kit for telephone work, all of which may be combined into a station, are given; and also a discussion of the construction of antenna systems for "ham" stations.

**PRACTICAL TELEVISION**, by E. T. Larner, A.I.E.E., of the engineering department of the (British) General Post Office, with a foreword by John L. Baird. Published by Ernest Benn, Ltd., London, England. Cloth, 224 pages, 5½ by 8½ in., 128 illustrations. Price, 10/6 (\$2.57).

This work covers the history of photoelectrical science, embracing both optics and electricity as they bear upon the problems of picture-transmission and television; and contains chapters on Selenium, Photoelectric Cells, Cathode Rays, and the various systems of television so far proposed or attempted. The final chapter describes the construction of a simple television receiver; the constants and parts of which are, however, so far as the radio channel goes, adapted only to British practice. (At the present time, television broadcasts in England are being given on the broadcast band; and in America they are ruled off this part of the spectrum.) The work is well written, and is in a clear and lucid style, well suited to the comprehension of the average reader.

Mr. Baird (whose familiarity with the subjects of television and the Shorter Catechism does not, obviously, extend to the text of the American constitution, concerning which he falls into error) expresses reasonable regret that the extreme popular interest, awakened by the electrical side of radio apparatus, has not extended to other branches of science; and points out the versatile education required of the television worker.

With all deference to the patriotic zeal of Mr. Larner, and with full acknowledgment of the splendid achievements of Mr. Baird (all of whose published utterances have a frank and impartial ring) we note that this work, like others published in England, is inclined to depreciate the efforts of Continental and American scientists. To say, in a 1929 edition of the work, that Dr. Alexanderson "has so far given no demonstrations," and that Mihaly "claims" to have achieved the transmission of shadows, is to impart that the reader must make allowances for the personal feelings of the author.

Having made this allowance, however, we find Mr. Larner's book to be an interesting and instructive one, from the standpoints of the radio enthusiast and the experimenter, and containing a considerable fund of practical information for the latter.

## RADIO-CRAFT'S INFORMATION BUREAU

(Continued from page 224)

speed of the motor, used in the converter described by Mr. Robbins, falls below 2,000 R.P.M.?

(A.1) To this inquiry, Mr. Robbins replies: "If the motor speed drops below 2,000, only the current frequency will suffer."

(Q.2) Is there any technical objection to the use of a commutator having a diameter of 1¼ in.?

(A.2) The commutator may have any dimension between the limits of ½ in. and 1½ in.

(Q.3) What was the make of the particular motor used in the construction of the converter pictured in this article?

(A.3) The motor used in the article in RADIO-CRAFT was a Model No. 700 motor made by Knapp Electric, Inc., Division of P. R. Mallory and Co., Port Chester, N. Y.

clusion of defective parts. It is suggested that every part used in the set be carefully tested, individually, for its rated characteristics.

If grounded shielding braid is used, the trouble may be due to a strand of the braid touching a lead from which it should be insulated.

Since it is reported that only local stations can be received, Mr. Auble suggests this procedure: disconnect the R.F. stage by removing the '22 (first R.F.) tube and the R.F. choke RF3 in its plate circuit. Next, connect the antenna to the stator of the tuning condenser C1, through a 3-plate "midget" variable condenser, and connect a ground connection to the "P" terminal of the tuning coil socket. This results in a standard three-tube short-wave receiver circuit.

Short-wave stations should now be received; and, if short-wave code stations cannot be heard, the detector circuit must be carefully checked to determine why this circuit does not oscillate. Now, by shorting the midget condenser, it will be possible to receive broadcast stations on any coil (try it). If the reception obtained in this manner seems to be the same as before, this would indicate that the original wiring included a short circuit of equivalent effect, which should be located and eliminated.

Although a few more turns in the tickler winding may cause the circuit to oscillate, there is probably some other cause for the lack of circuit oscillation, which should be found and corrected. For instance, the tubes may need changing. The '22 is a delicate tube and should be handled like a precision instrument; its filament circuit should include re-

### THE "COMPOSITE RECEIVER"

(92) Mr. Arthur Stazer, N. S. Pittsburgh, Pa.

(Q.) If the difficulties I am experiencing in getting to operate the "Composite Short-Wave Receiver" described by Mr. Robert N. Auble in the February, 1930, issue of RADIO-CRAFT are described to you, perhaps a remedy can be suggested. The set was laid out and wired in accordance with the instructions; all voltages are as specified. Only local broadcast stations can be heard, and the detector cannot be made to oscillate. What can be the cause of the trouble?

(A.) Mr. Auble points out that a not uncommon cause of trouble in home-built radio sets is the in-

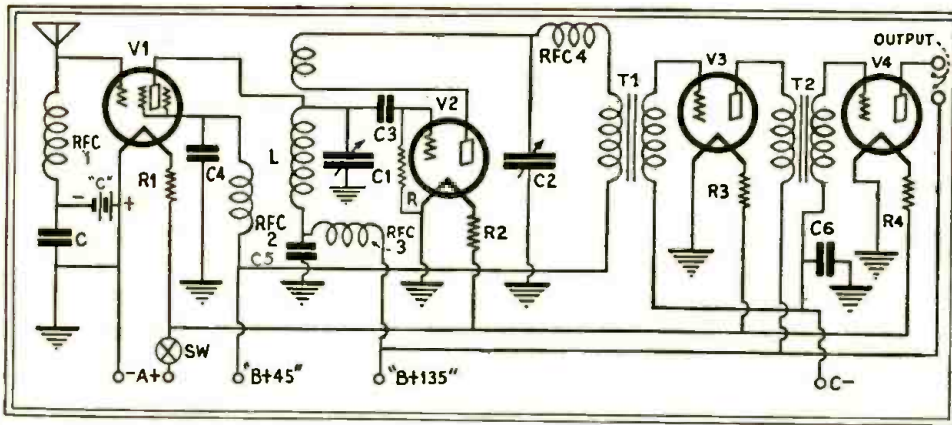

Fig. Q.92  
The circuit of Mr. Auble's "Composite" receiver, described in February RADIO-CRAFT.

sistors which will prevent the potential exceeding 3.3 V., as checked by an accurate meter. An increase in plate voltages may be desirable, and a grid condenser of .0001-mf. may work better. The "C" bias battery, also, may be connected backwards; check for correct polarity.

A source of trouble, which often escapes the attention of inexperienced constructors, is found in leaky insulators. Condenser insulation is sometimes poor; and the strips of insulation (particularly fiber) used to support instruments carrying R.F. currents, may leak to a great extent and cause what is popularly termed a "high-resistance short." A pair of headphones and a 45-volt battery in series are the suitable test equipment for locating faults of this sort.

**HE FILED HIS OWN**

Editor, RADIO-CRAFT:

In accordance with the request in your May issue, I will say that I constructed the Automatic Tuning Unit described in the article, making my own double-rotor condenser—which was a nice little job—with a couple of chisels and files and a hammer.

On June 22 I received with it W9XAA, W2XBU, W3NK, W2NAL, W2NE, W2XAF, CJRX, W8NK,

W2XU, W2XAD, W9XA, WOO, WENR, W2XAA, and the Detroit and Cincinnati police transmissions. Code just rolls in.

This is just a beginning of what this little unit will do; it is way ahead of any other I have tried out, and I have made several. I would be glad to hear from any fan about this little tuner, or about short-wave work.

C. H. BINGHAM,  
Sanford-Day Iron Works,  
Knoxville, Tenn.

**SHORT-WAVE LISTENERS' CONTEST**

On October 4 next, Station W9XAA, which operates on 49.34 meters from the Navy Pier at Chicago, will broadcast a special program, beginning at 9 p. m. Central Time, and continuing until 5 a. m. on October 5. The program, which has been arranged by the International Short-Wave Club, of Klondyke, Ohio, will be of unusual interest; announcements will be made in many languages. Prizes to be awarded to listeners who send in reports of reception, according to their merit, range from a ten-tube "Mercury" short-wave and broadcast receiver down. Short-wave listeners, regardless of the part of the world where they live, are eligible to compete.

**RECEPTION WITHOUT A "B" BATTERY**

Editor, RADIO-CRAFT:

Here is a very simple circuit—not a crystal—by means of which it is possible to receive without a "B" battery; a '99 or an '01A tube may be used. It is true that DX cannot be had on this circuit; the best I have done is WHO, Des Moines, 50 miles

on headphones. I have heard WOI, Ames, at 18 miles, and the local KFGQ, a 100-watt station.

My tuning coil and condenser are mounted end to end; the coil is 50 turns on a 3-inch form, center-tapped to the plate. The ground—not aerial—is connected to the grid (Fig. A). The choke coil is necessary. A resistor may be connected between the grid and the plate, but it works best without one.

It is necessary to tune very carefully, because no sound of any kind is heard until the station comes in.

AMOS HALL,  
1409 Twelfth Street,  
Boone, Iowa.

(Our correspondent has rediscovered the principle of the "Solodyne," which attracted some attention a few years ago. The difference in potential between the two ends of the filament causes a certain apparent plate voltage. It is very small; but on strong nearby stations, signals may be heard. The "Solodyne" was developed in Europe, using two-grid tubes which were not available on the American market. However, a circuit which will work fairly well with an ordinary tube, and give a greater degree of signal strength, may be hooked up as shown in Fig. B.—Editor.)

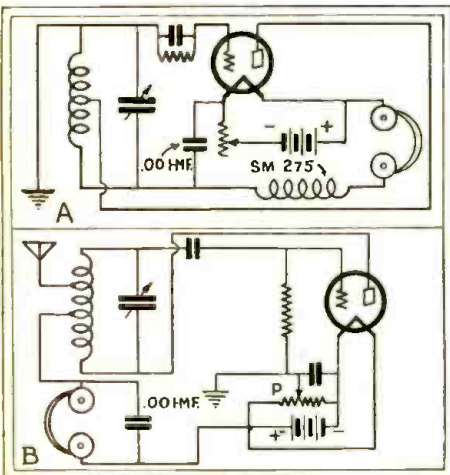

Above, the experimental circuit submitted by Mr. Hall; it is not very efficient. The Solodyne circuit below should give much stronger signals. The idea has met with much favor in Europe, where tube economy is the first question in design.

**BIG RADIO BARGAINS of the Day!**

OUR ENTIRE STOCK

**15% off**

already reduced prices

Thousands are taking advantage of this wonderful opportunity—and we feel proud of the fact that we are the leaders for lower prices.

7 Strand Copper Aerial Wire.....	\$0.15
7/22 Heavy Copper Aerial Wire.....	.29
7 Strand Enamel Aerial Wire.....	.19
7/22 Stranded Enamel Aerial Wire.....	.36
No. 14 Solid Enamel Aerial Wire.....	.39
Solid R.C. Lead-in Wire, Copper, 50 ft.....	.17
Solid R.C. Lead-in Wire, Copper, 100 ft.....	.34
Solid R.C. Lead-in Wire, Copper, 500 ft.....	1.65
Bell Wire, assorted colors, 1/2 lb. to box.....	.14
Glass Insulators, lots of 100.....	2.95
Porcelain Insulators, per 100.....	1.45
Lightning Arresters, lots of 25.....	1.45
Lightning Arresters, (large approved size), each	.21
Window Lead-in with Clips, lots of 100.....	2.95
Ground Clamp, large, with Clips, lots of 100.....	2.20
Radio Screw Drivers with Pocket Clips (A REAL SELLER—24 ON DISPLAY CARD).....	1.65
Gillett's Aerial and Lead-in Copper Connectors (A 10c. SELLER—24 ON DISPLAY CARD).....	1.35
Insulated Staples (1/2 in. and 3/4 in.) (100 to box, 10 boxes to carton), per carton.....	.83
White-head Nails (1,000 to box).....	1.45
Kester Rosin Core Solder (10 to display carton).....	1.65
Kester Rosin Core Solder (1-lb. spool).....	.49
Indoor Ribbon Aerial (100 ft. to box).....	.30
Hydrometers, Large (Heated Float).....	.23
Small Nickel-plated Test Clips (3c. each—lots of 50).....	1.25
Tasco Medium size Clips (Best in Country), 10 to box (lots of 100).....	5.25
Friction Tape (special 1/2-lb. box).....	.09
Friction Tape (First Quality) 1 oz.—32 to box; 2 oz.—16 to box; Display Cartons for each.....	.69
Edison Mazda Pilot Bulbs (6 volts and 2.5 volts) each box contains 10.....	.91
Eagle Air-cooled Prorex Tube—New Type.....	.50
Zero House Fuses (all amps., 10, 15, 20, 25, 30—packed 50 to carton).....	1.25
Rubber Unit Ferrules (to Connect Speaker Units), each.....	.05
Majestic Condenser "B" Blocks (for Replacement), Finest Quality.....	2.85
Majestic Condenser "A" Blocks (for Replacement), Finest Quality.....	5.25
Elkon Type "A" Block (Dumont) (for Replacement), 2,000-mfd., (Reduces Hum on Dynamic Speaker and "A" Eliminators).....	1.80
Kuprox Condenser Blocks.....	2.60
Dumont Socketenna (Combination Aerial and Light Socket).....	.42
Radio Control Clocks (Dialer) New Type.....	4.70
Dumont "A" Bone Dry Eliminator (Good for Any Set up to 10 Tubes).....	11.50
Hook-up Wire—25-ft. Rolls—Assorted Colors, Very Special.....	.14
Hook-up Wire—1,000 ft. on spool.....	5.50
Large Nail-It Knobs, per 100.....	1.35
Extension Cords—20-ft. Fancy Cords.....	.19
Extension Cords—30-ft. Fancy Cords.....	.29
Extension Cords—50-ft. Fancy Cords.....	.49
Loud Speaker Cords, Tips and Legs.....	.07
Fixture Wire—Stranded Cotton Covered—1,000 ft. on spool, colors—white or brown.....	3.35
Twisted Pair Lamp Cord, White with Trace—500 ft. on spool.....	3.85
Silk Parallel Lamp Cord—500 ft. on spool, colors—white, brown or gold.....	2.95
Trio Tap Extensions (A Handy Item), 6-ft. Silk Cord.....	.29
Utility Light (10-ft. Silk Lamp Cord), push through socket.....	.35
Heater Iron Cord Set (Special).....	.22
Screw-Eye Insulator, 3 in.....	.02
6 in. Capacity Drill Chuck; Handles Pulley for Driving Other Equipment—A WONDERFUL BUY.....	16.95

A remittance of 20% should accompany all C.O.D. orders—balance, plus a small charge for expressage, to be paid on delivery. Deduct 2% for full remittance.

NO ORDER LESS THAN \$3.00

**LEIMAN RADIO CO.**  
58-R Warren St., New York, N. Y.

# Brand New Merchandise

## At Unheard Of Prices

All articles shown on this page are brand new merchandise in original cartons, sold at prices never attempted heretofore. Inasmuch as the supply is limited, we reserve the right to return deposits if items have been sold out. Every article is fully guaranteed, yet all merchandise shown here is sold far below actual manufacturing cost. WE HAVE NO CATALOG. ORDER DIRECT FROM THIS PAGE.

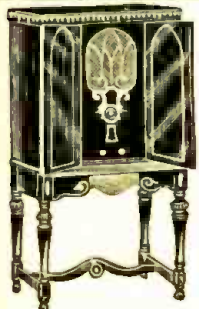

### Peerless Courier Model 21

One of the finest sets made. Uses 3 screen-grid tubes. Maximum selectivity, without sacrifice of tone. Uniform reception over entire broadcast range. Set is fully shielded and tuned by true single dial, operating four-gang ball-bearing condensers. Uses 3 - 224's (screen-grid), 2 - 227's, 2 - 245's and 1 - 280. For A.C., 110 volt, 60 cycle. Beautiful console model 46 in. high. Fine matched American Walnut and gumwood. Side panels and doors are matched in burl walnut. Selano overlay on top. Equipped with 9-in dynamic speaker.

In factory sealed case. Shipping weight 13 lbs. List Price, \$195.00 YOUR SPECIAL PRICE.....

**\$56.95**  
Tubes not included.

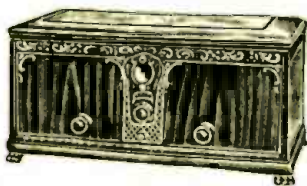

### Kolster Console K21

This fine set uses eight A.C. tubes. Small size and pretty of design. A welcome addition to the living room. Single control tuning. Only two other controls—a switch and a volume regulator. Works on 60 cycles, 110 volts A.C. Illuminated dial. Set uses 5 - 226, 1 - 171, 1 - 227, 1 - 280 tubes. Extra fine cabinet houses chassis. In factory sealed case.

Height 9 in., width 21 in., depth 13 in. Shipping weight 65 lbs.

List Price, \$160.00 YOUR SPECIAL PRICE..... **\$32.75**  
Tubes not included.

### Greater Steinite—Model 45



Operates on A.C. 110 volts, 60 cycle only. New chassis, using 5 - 227's, 1 - 280 and 2 - 171A's in push-pull. Double copper shielding. Four-gang condensers. New Steinite electro-dynamic speaker gives new conception of tonal beauty. Beautiful walnut console with diamond matched sliding doors. Height 53 in., width 29 in., depth 19 in. In factory sealed case. Shipping weight 150 lbs.

List Price, \$165.00 YOUR SPECIAL PRICE Marathon tubes included.

**\$48.25**

### Crosley Band Box—Model 601



Finest battery radio set built. Everyone knows a Crosley. The Band Box is a neodyne set employing 6 tubes—3 are radio frequency, balance detector and audio. Single station selector with illuminated dial. Set uses 6 - 201A's, 1 - 171A. Excellent distance setting ability and fine selectivity. Frosted brown crystalline finished cabinet. Set can be easily installed in console. In factory sealed case.

Shipping weight 21 lbs.

List Price, \$55.00 YOUR SPECIAL PRICE.....

**\$14.95**  
Tubes not included.

### Best Theatre Pickup



Best makes the best pickup anywhere. From a whisper to a thunderous volume. With this marvelous pickup you get tremendous volume, enough to tax the capacity of any speaker—and with the softest tonal quality that will surprise a musician. Pickup comes complete with volume control and adapter for four or five prong tubes (in case your set has no phonograph jack). In original factory sealed carton.

Shipping weight 3 lbs.

List Price, \$17.50

YOUR SPECIAL PRICE..... **\$5.85**

### The Columbia Radiograph



This remarkable new instrument enables you to play phonograph records through your radio loud speaker. Plugs into any radio set, whether same uses batteries or A.C. Connected to your radio in a jiffy. Equipped with fine electric motor operating only on A.C., 60 cycles, 110 volts. New Columbia pickup; volume control; special constant speed electric motor; automatic stop which operates on all records. Beautiful portable chest type. When closed, Radiograph is an artistic treasure-chest cabinet. In factory sealed case.

Shipping weight 18 lbs.

List Price, \$55.00

YOUR SPECIAL PRICE..... **\$13.90**

### Utah Dynamic A.C. Power Speaker—Model 33A

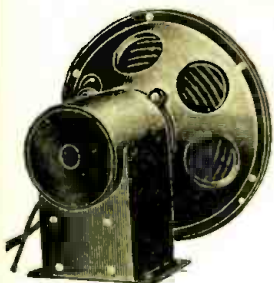

110 - volt, 60 - cycle A.C. light socket supply for field excitation using Westinghouse dry rectifier. 9 in. high, 9 1/2 in. wide, 7 1/2 in. deep. Speaker comes packed in wooden crate. Weight 19 lbs. It is one of the most powerful, as well as best reproducers in the market.

List Price, \$50.00 YOUR SPECIAL PRICE

**\$7.50**

### Peerless D.C. Dynamic Speaker



The ideal speaker for cabinet installation. Field resistance of 2500 ohms—90-120 volts with input transformer. This speaker can be used with A.C. receivers that are equipped to supply the "B" current to speaker field. Speaker comes to you packed in factory-sealed cartons.

Shipping weight 18 lbs.

List Price, \$17.50 YOUR SPECIAL PRICE..... **\$6.50**

### Zenith D.C. Dynamic Speaker

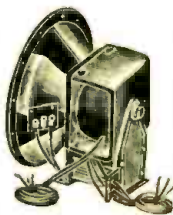

Field resistance, 600 ohms; operates direct from D.C. line. Output transformer (center-tapped) for 4 - 71A's in double push-pull, built into steel chassis. Can be connected to 1-power-tube sets. Replace filter chokes in electric sets with the field winding. Cone, 7 in., has extra large (2 in.) core. 9 in. high, 9 in. wide, 6 1/2 in. deep.

Packed in factory sealed cartons. Shipping weight 14 lbs.

List Price, \$35.00

YOUR SPECIAL PRICE..... **\$5.75**

### R.C.A. Loud Speaker 100B

A modern design loud speaker which will fit the modern trend in any home, yet harmonizes well with any set. Reproduces tones faithfully over a wide range and has great sensitivity. Handles a substantial volume of tone with remarkable clarity. Magnetic cone. Corrugated unit. Height, 10 3/4 in.; Width, 10 in.; Depth, 6 1/4 in.



Shipping weight 12 lbs.

List Price, \$17.50

YOUR SPECIAL PRICE.....

**\$5.20**

### R.C.A. Loud Speaker 103

A beautiful speaker in appearance. Superb in its ability to reproduce music and speech most faithfully. The frame and pedestal are mounted to resemble hand-carved oak, while the beautiful tapestry medallion conceals the mechanism and completes the decorative design of the instrument. Magnetic unit. Corrugated cone. Height, 15 in.; Width, 13 1/2 in.; Depth, 6 1/4 in. In factory sealed carton. Shipping weight 14 lbs.



List Price, \$22.50

YOUR SPECIAL PRICE..... **\$5.25**

### Peerless A.C. Dynamic Mantel Cabinet Speaker—Model 19A



Size: 16 5/16 in. high at center; 14 1/2 in. wide at base; 10 3/16 in. deep at base. Diameter of cone, 9 in. Chassis specifications: Extremely solidly built. Power transformer and rectifier assembled as a unit with chassis. Each reproducer equipped with 8 feet of silk-covered power cord with plug and switch, and 8 feet of silk-covered speaker cord with phone tips. Equipped with power transformer and rectifier to operate on 110-volt, 50-60 cycle, A.C. current.

Shipping weight 43 lbs. List Price, \$75.00

YOUR SPECIAL PRICE..... **\$14.50**

ORDER DIRECT FROM THIS PAGE.

If C. O. D. shipment is desired, please remit 20% remittance, which must accompany all orders; balance on delivery.

If the full cash amount accompanies the order, you may deduct 2% discount.

**Radio Trading Co.**  
246 Fifth Avenue  
New York, N. Y.

Should you wish goods shipped by parcel post, be sure to include sufficient extra remittance for same. Any excess will be refunded.

We have no catalog but you will find special offers from time to time in this magazine. Prompt shipments will be made.

Believe it or not . . . . . London . . .

Tokio . . .

“Down Under” . . .

ON REGULAR BROADCAST WAVES  
ON YOUR LOUD SPEAKER

# Find-All Screen Grid FOUR

## AC . . . . or battery-operated . . . . NOT a short-Wave Set!

ELECTRIC

A “FOUR” tuber as powerful as any “seven” With a world’s record for round-the-world loud-speaker reception . . . now available for LAMP-SOCKET operation in one of the handsomest miniature cabinets ever presented to Radio! In all the history of Radio you’ve never been offered so astoundingly MUCH for so amazingly LITTLE! Anyone can operate it . . . anyone can BUILD it (with the aid of our helpful blue print and a FIND-ALL Kit). Working on ordinary broadcast wave lengths, this superlative set actually eclipses all records for distance reception . . . bringing in stations from the other hemisphere, often under perfectly average conditions! For a revelation in clear, golden-tongued performance, COMPARE the sensational new FIND-ALL A.C. Electric Set with the most expensive and elaborate model of any make you choose . . . and FIND-ALL will win on each and every count!

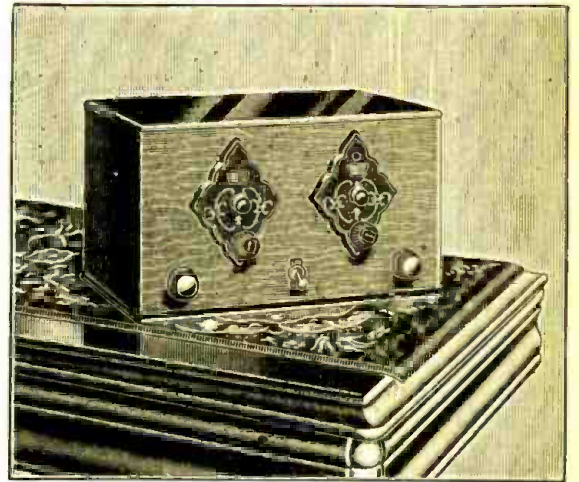

A Beautiful Table Model in Finest Walnut . . . to Enhance Any Room! The Original “Mantelpiece” Midget Receiver

### Sensitive . . . Selective . . . Powerful . . . Trouble-free!

AND LOOK AT THE SENSATIONAL PRICES

A set without a flaw! Designed by a foremost radio engineer, widely known for his contributions to the industry. Clear, life-like reception made sharper by simple 2-dial control. A cabinet that measures only 7 by 7 by 12 inches. Aluminum chassis, highest type wiring and connections. Surprising volume, even when you’re listening to distant stations. Works equally well with magnetic or dynamic reproducer. The proud holder of a record of 12,000 miles of verified loud-speaker reception of a 100-watt station! Write us for testimonials.

The FIND-ALL Screen-Grid A.C. FOUR can be assembled and wired by any novice in a very short time, chassis being furnished completely drilled. Our absolute guarantee as to material and workmanship carries with every set sold.



Complete Table Model or in Kit Form  
Direct from Factory at Remarkable Prices

<b>AC</b>	<b>Find-All Screen-Grid Four</b>
<b>ELECTRIC</b>	
Cabinet Model . . . . .	<b>\$46.95</b>
(wired complete)	
Complete Kit . . . . .	<b>\$35.00</b>
<b>BATTERY OPERATED</b>	
Cabinet Model . . . . .	<b>\$35.00</b>
(wired complete)	
Complete Kit . . . . .	<b>\$25.00</b>

All Prices f.o.b. New York City. 5% Discount Cash with Order or Enclose \$5 with C.O.D. Order—Pay Postman Balance

W. H. SIPE, SEWICKLEY, PA., recorded with a FIND-ALL battery set, on February 7th, 1929, stations located in Los Angeles, New York City and other distant cities.

JOHN KORSEN, BROOKLYN, about the same time, reported receiving in one night Salt Lake City, Chicago, Hollywood, Toronto, Sydney, Australia, received by several others. Write for testimonials and logs.

### Send for Blue Print

Actuated by the wide national interest aroused as soon as we announced this sensational set, we have provided a very helpful blue print (either A.C. or battery) to aid you in assembling the FIND-ALL Screen-Grid FOUR Set. In writing for blue print, state whether A.C. or battery . . . and enclose the sum of

**\$1.00**

DEALERS—Find-All Means Business for You—No Conflict with Bigger Sets

## FIND-ALL RADIO CO.

Designers and Manufacturers of Custom Built Radios

Suite 200  
94 Park Place

Find-All  
Screen-Grid  
FOUR

New York, N. Y.

# Surplus Sale of Nationally Advertised Radio Merchandise

# SEND NO MONEY!

All merchandise listed on this page is sent to you by express, C.O.D., WITH FULL PRIVILEGE OF INSPECTION. You risk absolutely nothing and the express agent will allow you to open the package so you can satisfy yourself that the merchandise is as represented. We do not require a deposit from you—WE TRUST YOU. Prices are F.O.B. New York, express charges to be paid by you. C.O.D. privilege is good only in continental United States.

## Allen A.C. Phono. Motor

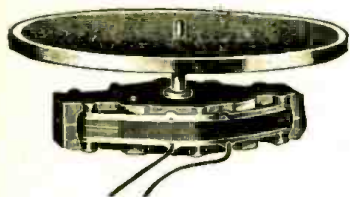

WITH TURN-TABLE

Reg. \$35.00 **\$4.45**

Most Compact Made

A sturdy SYNCHRONOUS, compact motor, ONLY 1/4 IN. THICK, with dependability and stamina that make it a marvel of engineering. REVOLVES EXACTLY 80 TIMES IN ONE MINUTE, which is standard, REGARDLESS OF VOLTAGE FLUCTUATIONS! CAN FIT INTO MOST ANY AVAILABLE SPACE. COMPLETE WITH TURN-TABLE. FOR 110-VOLT A.C. Shipping weight, 10 lbs.

## SM 250 Power Amplifier



Contains two stages of power a.f. amplification. Ideal for theatres, dance halls, schools, lecture halls, hospitals, auditoriums, outdoor gatherings, etc., etc. The gigantic power output is at all times within control—FOR THAT MATTER IT CAN BE USED IN ANY HOME, AS THE VOLUME CAN BE THROTTLED DOWN TO A WHISPER. ASSEMBLED IN

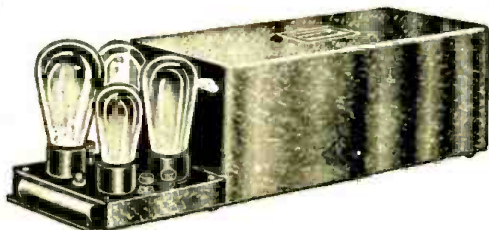

Reg. \$125.00 **\$22.50**

WORLD RENOWNED SILVER-MARSHALL LABORATORIES. Can be used with ANY RADIO TUNER—PHONOGRAPH PICK-UP—MICROPHONE ARRANGEMENT. SUPPLIES ALL "A B C" CURRENT TO ITS OWN TUBES—all self contained. Uses ONE 250—ONE 226—TWO 281 TUBES (not included—\$5.00 additional). 21 x 5 3/4 x 5 1/2 inches—shipped express collect.

Reg. \$15.00 **375**

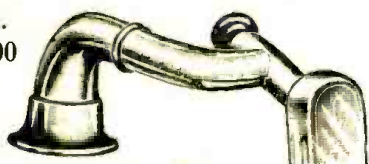

Pacentic Pk-up

Note that this tone arm rests on its own base — on the end remote from the unit itself. There is a considerable weight which "counterbalances" the weight beyond the pivot. Weight on record is only about three ounces, greatly reducing scratching, and increases the life of all records. Due to construction of tone arm, the unit is always set at the correct angle, with reference to the surface of the record. Pedestal does not have to be screwed down to the phonograph platform. For use with either A.C. or D.C. sets. Shipping weight, 4 lbs.

SEND NO MONEY!  
WE SHIP C.O.D. WITH PRIVILEGE OF INSPECTION

**FREE RADIO BOOKLET**  
**FULL OF BARGAINS**  
SEND FOR IT TO-DAY

WE MAKE FREQUENT MAILINGS OF SPECIAL BULLETINS — IT WILL PAY YOU TO BE ON OUR MAILING LIST

## RCA SPEAKER CHASSIS

**\$3.75**

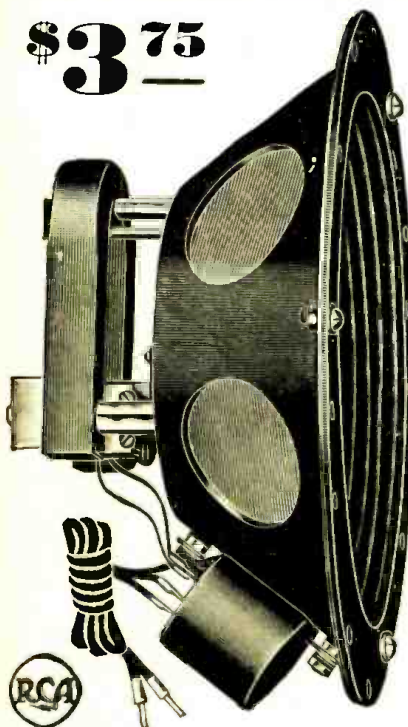

TWO OF THE GREATEST ORGANIZATIONS IN THE RADIO INDUSTRY, GENERAL ELECTRIC COMPANY AND RADIO CORPORATION OF AMERICA, ARE SPONSORS OF THIS PRODUCT! This chassis is the identical one used in the RCA Model 100A and 100B Speakers, WHICH LIST FOR AS HIGH AS \$35.00.

Note built-in OUTPUT TRANSFORMER—this enables the speaker to be used with voltages applied to it as high as 450 volts, without any trace of distortion, rattling or blasting. Equipped with GENEROUS OVER-SIZED MAGNETS. The thick armature is ACCURATELY CENTERED. The STURDY METAL FRAME IS LINED WITH A SELF-BAFFLING FABRIC, greatly improving the acoustic properties of this sensational speaker! NOTE THE CORRUGATED SURFACE OF THE CONE, AN EXCLUSIVE FEATURE—ENHANCES PERFECT TONAL REPRODUCTION QUALITIES CONSIDERABLY. MOST COMPACTLY MADE: 9 INCHES OUTSIDE DIAMETER, 4 1/2 INCHES DEEP OVER-ALL.

IDEAL FOR AUTOMOBILE RADIO SPEAKER INSTALLATION — CAN BE MOUNTED IN ANY RADIO CONSOLE, or against any baffle arrangement. Complete with durable 5-foot cord. Shipping weight, 5 lbs.

SPEAKER CHAMBER FOR ABOVE CHASSIS  
This speaker can be installed in this special ACOUSTICALLY PERFECT BAFFLE CHAMBER in a few moments. Front baffle board included.  
OUR SPECIAL PRICE ..... 85c.



Note post office department does not allow inspection of parcel-post shipments. If cash accompanies order for full amount deduct 2% discount. Include postage allowance if parcel-post shipment is desired—any excess will be refunded. Send check, money order, cash (registered mail) or U. S. stamps, any denominations.

FARRAND INDUCTOR DYNAMIC CHASSIS  
Here is not only true Dynamic operation and performance at a popular price, but opportunity to enjoy dynamic reception from every type of radio receiver. Outside diameter, 8 3/4 in. Cone Depth, 7 1/2 in. Shipping weight, 10 lbs.  
REG. \$18.00



**\$8.49**

## BBL GIANT ELECTRIC MOTOR SPEAKER CHASSIS

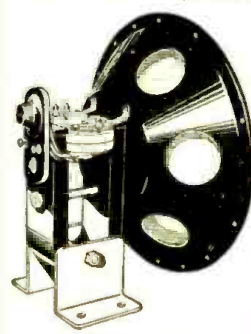

12 IN. OVER-ALL DIAMETER  
The motor (unit) used in this speaker is approximately 4 times the size of the original BBL unit, or most any other unit—therefore is capable of handling terrific power. Due to its extremely large permanent magnet, its efficiency surpasses that of all other magnetic speakers, and some dynamies. Uncanny fidelity of reproduction! Equipped with tapped impedance windings, enable you to select any of 3 impedances, to properly match your amplifier, and thereby give you the most realistic tone!

Reg. \$22.00 **\$6.95**

## LOFTIN-WHITE LICENSED DIRECT COUPLED AMPLIFIERS

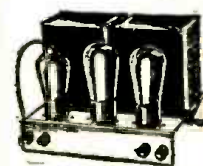

A most remarkable and inexpensive amplifier for use in electrical reproduction of phonograph records and public address systems in halls, schools, churches and auditoriums. Very compact! Modernize any tuner! Shipping weight, 15 lbs.  
Model 245 ..... \$16.50  
Model 250 ..... 29.50

THORDARSON SPECIALS  
2 1/2 volt, 12-ampere Fil. Transformer ..... \$3.15  
R171 or R210 Compact (Power Transformer and 2 Chokes in one case) ..... 4.89  
250 Push-Pull Power Transformer, for 2-250 .....  
2-281, 5-227 Tubes ..... 4.50  
S.M. 251-255-256 Audio Transformers ..... 2.45  
Webster 2A Phono. Pick-up ..... 8.75

# Radio Surplus Corp.

56 R VESEY ST. • NEW YORK, N. Y.

ALL MERCHANDISE IS BRAND NEW AND COMES IN ORIGINAL SEALED CARTONS

WE GUARANTEE YOU 100% SATISFACTION—YOU RISK NOTHING

WE MAKE SHIPMENTS SAME DAY ORDER IS RECEIVED!



FACTORY TO YOU—SAVE to 50%—COMPARE WITH COSTLIEST OUTFITS BEFORE YOU BUY

# Enjoy a powerful new Miraco 30 DAYS FREE

Latest 1931 SUPER Screen Grid Outfit (No obligation to buy)

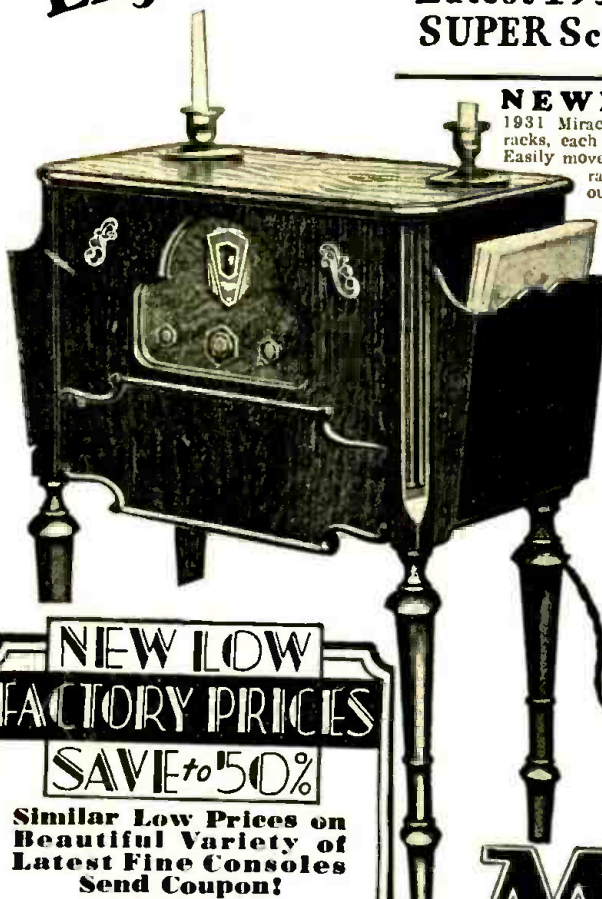

### NEWEST IN RADIO!

1931 Miraco "Easy-Chair" model with magazine racks, each end. Place it anywhere in any room. Easily moved about. Contains a complete full-size radio and Super-Dynamic speaker! No outside aerial or ground required. Many other new, clever models, obtainable nowhere else, shown in free literature.

Get Our "SEND NO MONEY" 11th Anniversary Offer!

Latest 1931 **Super Screen Grid** FULL YEAR'S GUAR.  
lighted dial steel chassis  
Vari-Tone and Automatic Sensitivity Control  
Also latest PUSH-PULL Amplification

Built like—looks like—performs like newest radios in many outfits much more costly. Latest, finest, heavy duty construction. Skilfully engineered to super-utilize a battery of "224" SCREEN GRID tubes—in addition to "245" PUSH-PULL POWER, "224" HUM-FREE long-lived POWER DETECTOR and AMPLIFIER and "280" A-C TUBES. Vari-tone feature gives any tone-pitch your ears prefer. Automatic Sensitivity Control reduces "fading," protects tubes. Phonograph pick-up connection. Built-in house wiring aerial and ground. Built-in plug for electric clock, lighter, lamp, etc. Super-sturdy power section. Razor-edge selectivity; Super-Dynamic Cathedral tone quality; marvelous distance-getter. Solid one-year guarantee if you buy! Wide choice of cabinets.

Easy Chair Model

Only \$49.88 COMPLETELY ASSEMBLED

Values possible because you deal direct with big factory

# MIRACO

TRADE MARK REGISTERED

CATHEDRAL TONED, SUPER SELECTIVE, POWERFUL DISTANCE GETTERS

You need not send us a cent! For its 11th successful year, America's big, old, reliable Radio Factory again sets the pace in high-grade, latest guaranteed radios direct to you. And now—at history's greatest savings. With this newest perfected SUPER SCREEN GRID, push-pull, super-powered and humless electric AC set in clever, beautiful new Miraco Mastercrest consoles obtainable nowhere else—you are guaranteed satisfaction, values and savings unsurpassed. Get Amazing Special Offer!

### Don't Confuse with Cheap Radios

With Miraco's rich, clear Cathedral Tone, quiet operation, razor-sharp separation of nearby stations, tremendous "kick" on distant stations, Vari-Tone and automatic sensitivity control, and other latest features—be the envy of many who pay 2 or 3 times as much!

EASY TERMS to reliable persons only

### USER-AGENTS WANTED

Exclusive Territory—Try it at Our Risk!

Spare or full time. No contract, no experience required. Big money! Send coupon now!

Send for proof that delighted thousands of Miraco users cut through locals, get coast to coast, with tone and power of costly sets.

Miraco's are built of finest parts—approved by Radio's highest authorities. Our 11th successful year!

### Deal Direct with Big Factory

Miraco outfits arrive splendidly packed, rigidly tested, to plug in like a lamp and enjoy at once. No experience needed. Entertain yourself 30 days—then decide. Liberal year's guarantee if you buy. Play safe, save lots of money, insure satisfaction—deal direct with Radio's big, reliable, pioneer builders of fine sets—successful since 1920. SEND POSTAL OR COUPON NOW for Amazing Offer!



At our risk, compare a Miraco outfit with highest priced radios 30 days and nights. Surprise, entertain your friends—get their opinions. Unless 100% delighted, don't buy! Your decision is final—no argument!

Only marvelously fine radios, of latest perfected type, at rock-bottom prices, can back up such a guarantee. Send postal or coupon for Amazing Special Factory Offer!

MIDWEST RADIO CORP. 895-AO Miraco Dept., Cincinnati, Ohio

### BEAUTIFULLY ILLUSTRATED LITERATURE, TESTIMONY OF NEARBY USERS, PROOF OF OUR RELIABILITY—

All the proof you want—of our honesty, fairness, size, financial integrity, radio experience and the performance of our sets—including Amazing Factory Offer—sent without obligation!

Free!

MIDWEST RADIO CORPORATION Pioneer Builders of Sets—11th Successful Year 895-AO Miraco Dept., Cincinnati, Ohio

THIS COUPON IS NOT AN ORDER

- WITHOUT OBLIGATION, send latest literature, Amazing Special Free Trial Send-No-Money Offer, testimony of nearby users and all Proof.  User.  Agent.  Dealer
- Check here if interested in an EXCLUSIVE TERRITORY PROPOSITION
- NAME..... ADDRESS.....

NEW LOW FACTORY PRICES SAVE to 50% Similar Low Prices on Beautiful Variety of Latest Fine Consoles Send Coupon! 30 DAYS' FREE TRIAL



Full-size wall console with latest 1931 features. Beautiful design and woods. Priced very low, factory to you.

Popular "Lo-Boy". Takes very little space. Stores haven't anything as classy at \$50.00 more.



Medium-size "Hi-Boy". Sliding doors. Rich design, fine woods, fine finish. Astonishingly low factory price to you.

These Consoles are Equipped with SUPER DYNAMIC CATHEDRAL TONE REPRODUCERS

Also built-in aerial and ground and built-in extra light socket!

Magnificent new creation. Super Screen Grid Radio. Phonograph under same lid. Greatly under priced. Send coupon for low factory to you prices.



# ALL the Latest Features in Radio Receivers!

Screen Grid, Tone Control  
Dynamic Speakers  
All-Electric Sets, Battery Sets



**EVERYTHING  
AT  
WHOLESALE  
PRICES**

### Tune In On This Catalog

This remarkable book of Radio Bargains — 168 pages and over 500 illustrations — contains all the latest and best in Radio equipment—sets, accessories, parts and kits—priced so low it will startle you!

All the standard devices and last-minute improvements—New 1931 Screen Grid, Tone Control, A. C. Humless All-Electric Sets, Public Address, Phono-Combinations, Dynamic Speakers, Beautiful Consoles. Also battery operated sets.

A brand new Slot Machine Radio, coin-operated—offers extra profits for restaurants, stores, hotels and other public places.

### Radio's Greatest Money-Savers!

All this wonderful line of radio merchandise is available to you at Wholesale Prices—bed-rock figures and the most

unusual values ever catalogued. Our tremendous buying power makes this possible. From first to last page this

Catalog is brimful of astounding bargains—money-saving items and information. Send for it today. It's FREE.

The House  
Of  
Outstanding  
Values

# ALLIED RADIO CORPORATION

Resources  
Over Three  
Million  
Dollars

711 W. Lake Street Dept. R, Chicago

# WHAT EVERY ELECTRICIAN WANTS TO KNOW!

**JUST OUT!**—Latest Exact Information from A to Z!

We take pleasure in announcing: "AUDELS NEW ELECTRIC LIBRARY"

New and More Uses for Electricity offer great opportunities to men who can handle this power correctly. Modern electrification of industry calls for trained men who know how to handle electricity accurately.

Simple as A. B. C.—"Audels New Electric Library" gives latest, exact information from foundations of electrical practice to latest modern applications. This is a NEW practical and theoretical course in electricity for home study and ready reference.

Here are the answers to your questions, giving you the real dope that every electrician must know. They chart your knowledge, taking away the uncertainty of guess work.

**NEW!**

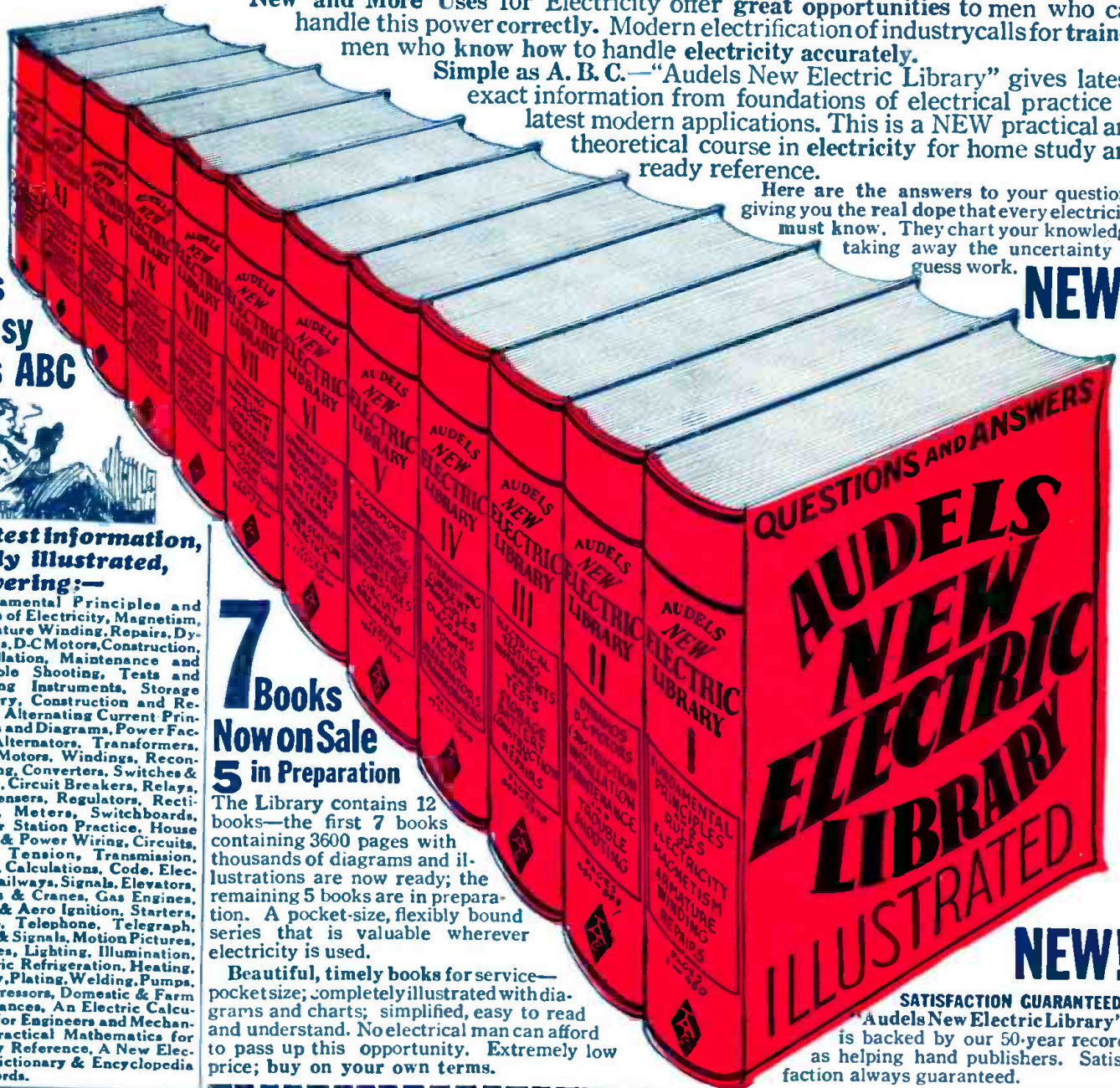

As Easy As ABC



Latest information, fully illustrated, covering:—

Fundamental Principles and Rules of Electricity, Magnetism, Armature Winding, Repairs, Dynamos, D.C. Motors, Construction, Installation, Maintenance and Trouble Shooting, Tests and Testing Instruments, Storage Battery, Construction and Repairs, Alternating Current Principles and Diagrams, Power Factor, Alternators, Transformers, A-C Motors, Windings, Reconnecting, Converters, Switches & Fuses, Circuit Breakers, Relays, Condensers, Regulators, Rectifiers, Meters, Switchboards, Power Station Practice, House Light & Power Wiring, Circuits, High Tension, Transmission, Plans, Calculations, Code, Electric Railways, Signals, Elevators, Hoists & Cranes, Gas Engines, Auto & Aero Ignition, Starters, Radio, Telephone, Telegraph, Bells & Signals, Motion Pictures, Talkies, Lighting, Illumination, Electric Refrigeration, Heating, X-Ray, Plating, Welding, Pumps, Compressors, Domestic & Farm Appliances, An Electric Calculator for Engineers and Mechanics, Practical Mathematics for Ready Reference, A New Electric Dictionary & Encyclopedia of Words.

**7 Books Now on Sale 5 in Preparation**

The Library contains 12 books—the first 7 books containing 3600 pages with thousands of diagrams and illustrations are now ready; the remaining 5 books are in preparation. A pocket-size, flexibly bound series that is valuable wherever electricity is used.

Beautiful, timely books for service—pocket size; completely illustrated with diagrams and charts; simplified, easy to read and understand. No electrical man can afford to pass up this opportunity. Extremely low price; buy on your own terms.

**NEW!**

**SATISFACTION GUARANTEED!** "Audels New Electric Library" is backed by our 50-year record as helping hand publishers. Satisfaction always guaranteed.

Beautiful, Timely Books

**POCKET SIZE**

Read for Profit

**BUY ON YOUR OWN TERMS**

**PLAN 1—ONE BOOK A MONTH**  
Please enter my subscription to "Audels New Electric Library" to consist of twelve volumes, price \$1.50 a volume (\$10.50 for the seven volumes now ready). Mail one volume each month and as they are received, I will mail you \$1.50 promptly.

**PLAN 2—PAY 50c OR MORE A WEEK**  
Please ship me for one week's free trial the first seven volumes of "Audels New Electric Library," \$1.50 each (\$10.50 for the seven volumes now ready). The remaining five volumes to be mailed as issued at \$1.50 a volume. If satisfied, I will mail you 50c or more each week as payment for the first seven books and I will pay for the last five numbers as I receive them at \$1.50 each.

**PLAN 3—CASH PRICE \$9.98**  
Please ship me postpaid "Audels New Electric Library" for which I enclose remittance \$9.98 in full payment for the seven volumes now ready. You are to ship me on one week's trial the remaining five volumes as they are issued for which I will either pay \$1.50 each as received or return to you. This price is based on 6% cash discount.

THEO. AUDEL & CO.,  
65 West 23rd St., New York, N. Y.

Please ship me the NEW "Audels Electric Library" on the plan marked (X).

NAME .....

ADDRESS .....

OCCUPATION .....

EMPLOYED BY .....

Ger

# The Biggest Value Ever Offered in a Radio Set Analyzer



**Dealers' Price \$73.12**  
List Price - - - \$97.50

The Jewell Pattern 199 is unequalled in accuracy, speed, and simplicity of operation by any other analyzer of comparable price.

**W**HY consider inferior set testers when a Jewell Pattern 199 Set Analyzer, proved through more than two years' service, costs so little?

Accuracy is vital in a radio service instrument. The large meters of the Pattern 199 are inherently accurate. These meters have been proved on thousands and thousands of industrial applications. Their clearly marked legible scales are easy to read accurately.

Why consider an instrument that requires an encyclopedia to tell how to operate it? The Jewell Pattern 199 is so simple to operate that if you leave the instruction book at home you need experience no difficulty.

Why experiment with cheap, inferior testers? The Jewell Pattern 199 is built to the highest standards by an exclusive man-

ufacturer of instruments. The only changes in the Pattern 199 in more than two years are adjustments to take care of new factors in radio equipment.

In the Jewell Pattern 199 you get a proven set analyzer—there are more than fifteen thousand of them in service today—an analyzer with two large, easy-to-read meters—an analyzer that is inherently accurate, durable and reliable—an analyzer that is simple to operate—an analyzer that makes every worthwhile field test—at a price made possible only by quantity production.

Again we repeat—you may be able to buy some kind of a set analyzer for less money, but you can't get as much for your money in any other analyzer on the market as you get in the Jewell Pattern 199.

30 YEARS MAKING GOOD INSTRUMENTS  
**JEWELL**  
Pattern 199 Set Analyzer

Jewell Electrical Instrument Company  
1612-K Walnut St., Chicago, Illinois

Mail your 16-page bulletin describing the Pattern 199 Set Analyzer and other Jewell Service Instruments.

Name.....

Address.....